



MANUAL N° 810 - 2

**FOURTH SECTION**

**BODYWORK**

FOURTH SECTION

**LIST OF OPERATIONS**  
**IN THE FOURTH SECTION OF THE MANUAL N° 810-2**

Operations where the number is preceded by the letter « G » are common to all types of vehicles of the « GS » family.

Operations where the number is preceded by the letters « GE » or « GF » are specific to the five-or three-door versions of the « GS » Estate respectively.

Operations where the number is preceded by the letter « Gea » are specific to vehicles fitted with a Torque Converter.

| Operations<br>Number | DESCRIPTION   |
|----------------------|---|
|                      | <b>BODYWORK</b>   |
| G. 800-00            | Body preparation<br>- Sealing with sealing compound<br>- Soundproofing  |
| G. 800-0             | Checking the body   |
|                      | <b>BODY PANEL WORK</b>  |
| G. 961-1 a           | Replacement of a windscreen   |
| GFv 961-4            | Work on the side windows<br>- Replacing a side window   |
| G. 961-7             | Work on the rear window<br>- Replacement of the rear window   |
| GE.961-7             | Work on the rear tailgate<br>- Replacement of a « bonded » tailgate window<br>- Replacement of a « set-in » tailgate window |

**SEALING WITH SEALING COMPOUND**

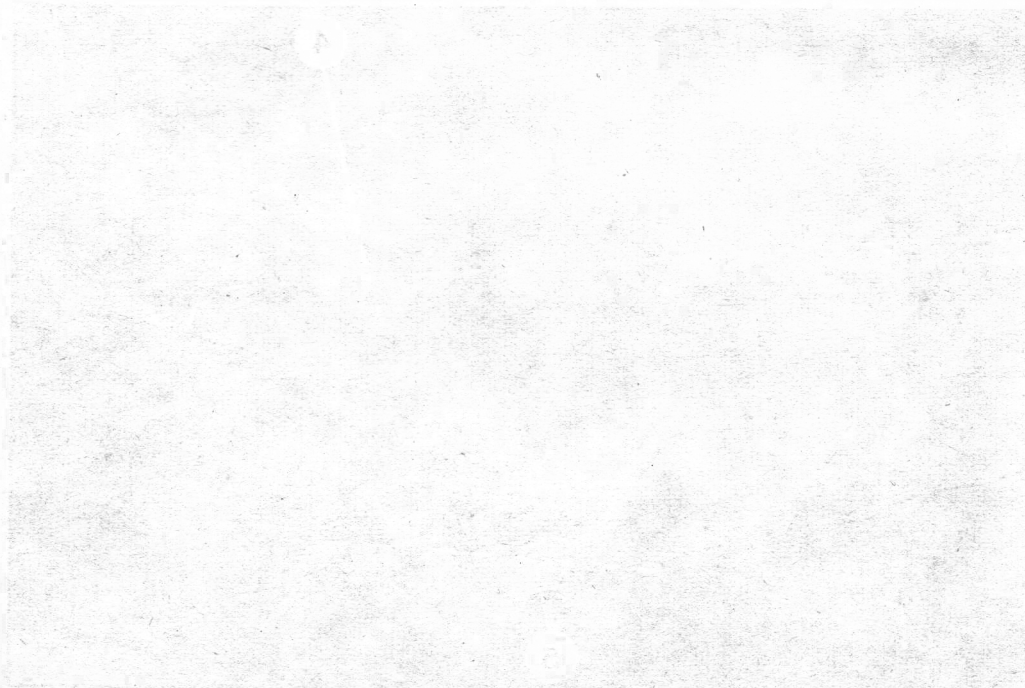
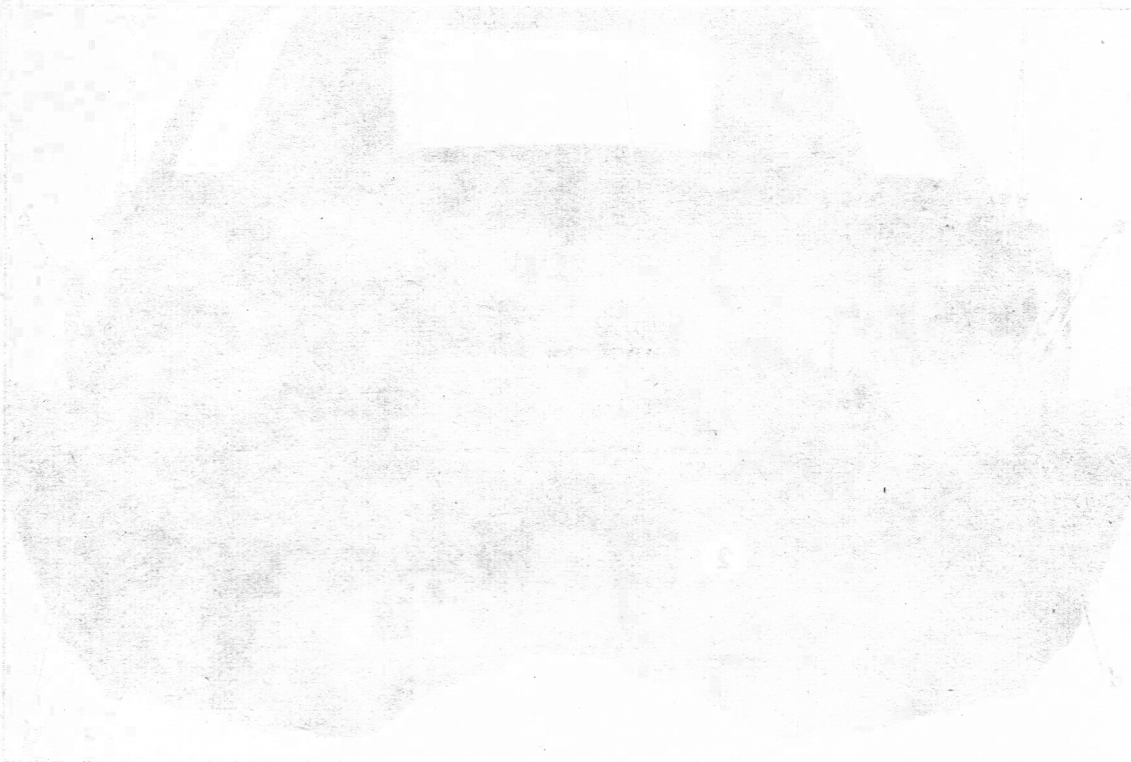

Manual 810-2

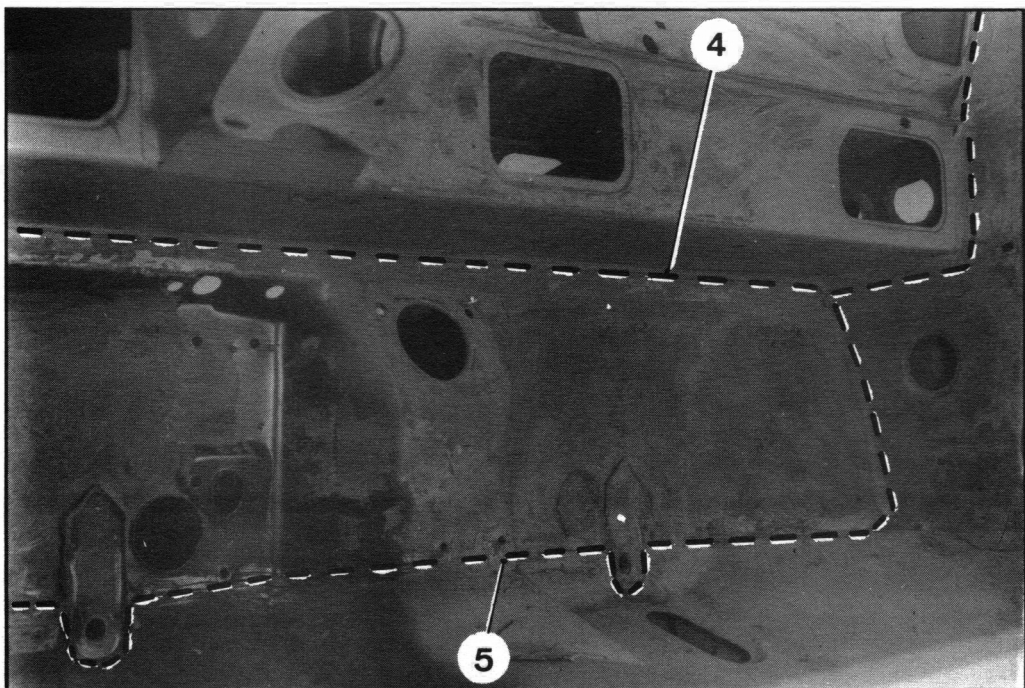
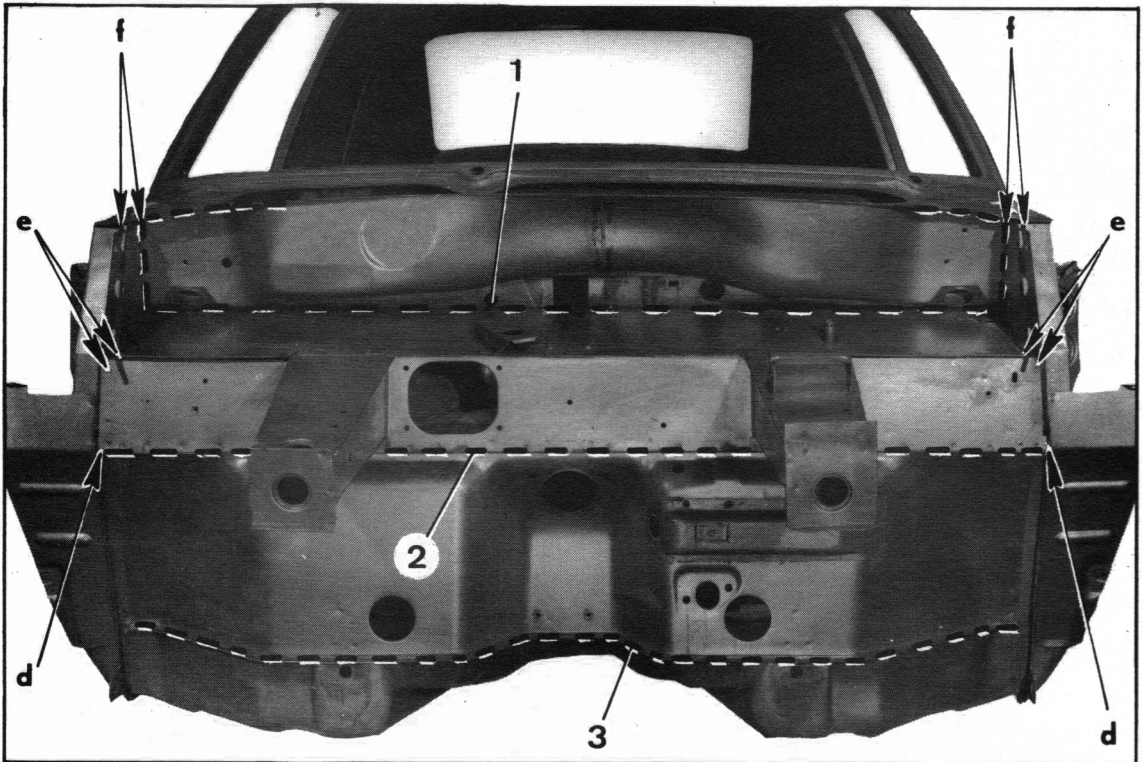
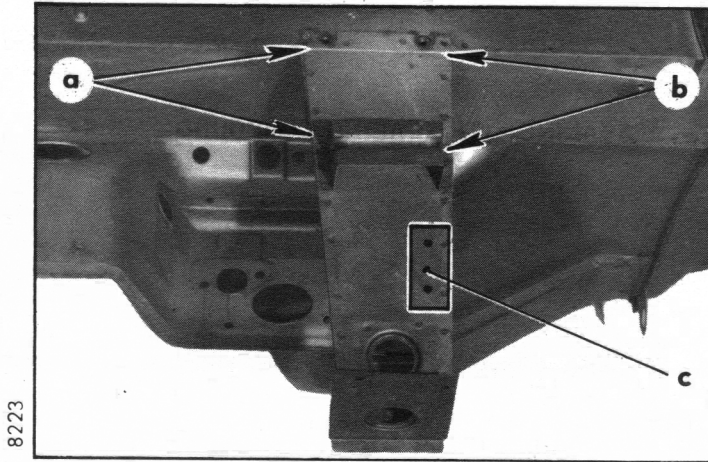

8251

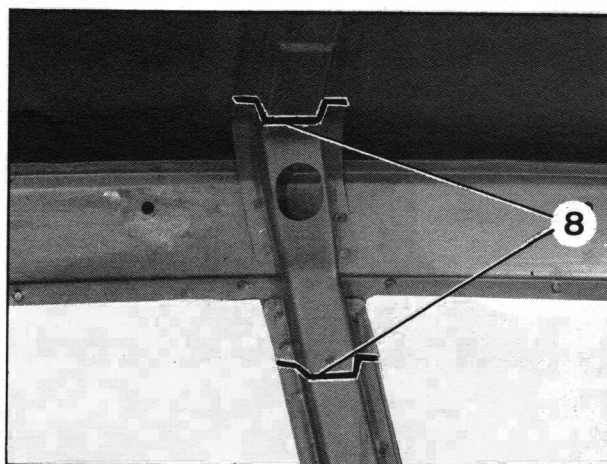
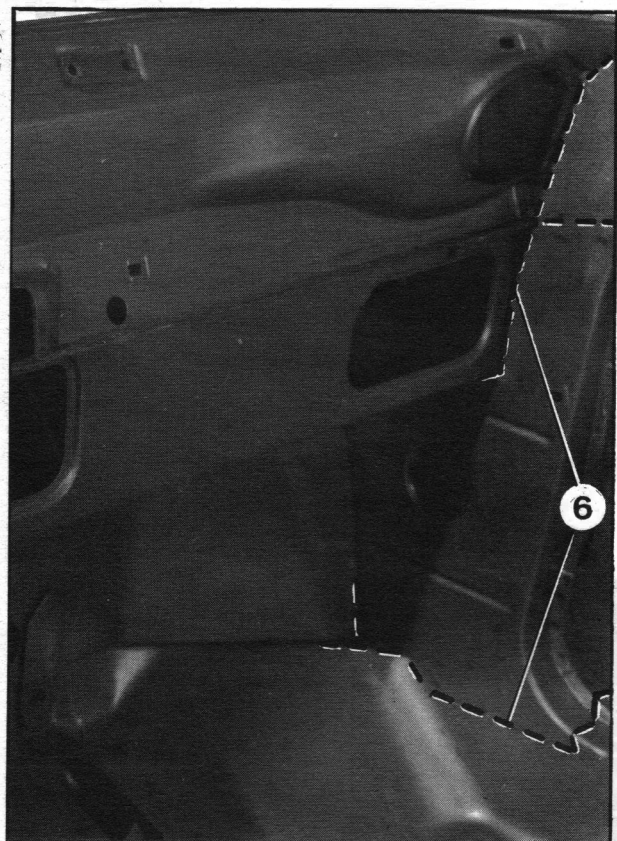

8216

Seal the seams and points as indicated below :

## FRONT

- **Extensions :**

*On the left-hand side only :* Blank the holes at « c » (adhesive tape 80 × 25 mm).

*On each side :* Join of plates at « a », « b » and « c ».

- **Line 1 :** Junction of dashboard/ intake assembly with extension assembly.

*On each side :* Junction of plates at « f ».

- **Line 2 :** Junction of extension assembly with the lower body panel.

*On each side :* Junction of the plates at « d ».

- **Line 3 :** Junction of the lower body panel with the central chassis.

- **Line 4 :** Junction of the lower body panel with the extension plate.

- **Line 5 :** Junction of the lower body panel with the central chassis.

- **Line 6 :** Junction of the front body panel with the side panel *on each side.*

- **Line 7 :** Junction of the front pillar with the hinge support panel *on each side.*

## BODY

- **Line 8 :** Junction of the centre pillar with the roof crossmember *on the inside and on each side.*

Manual 810-2

8220

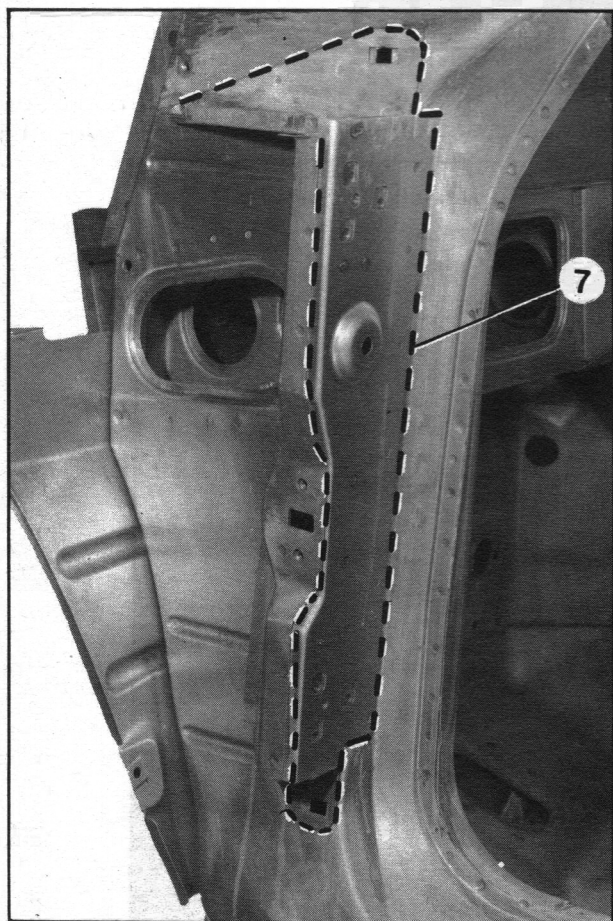

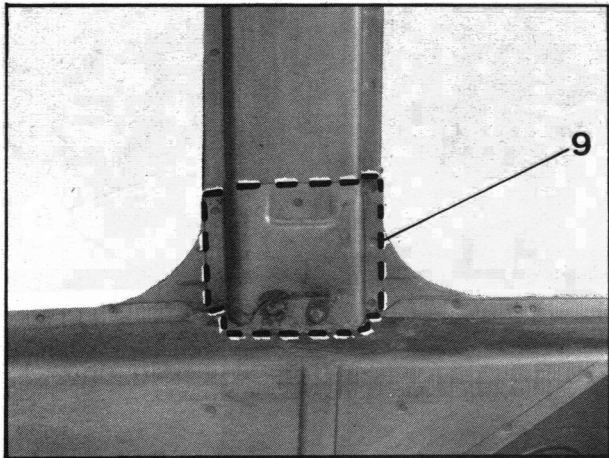

8217

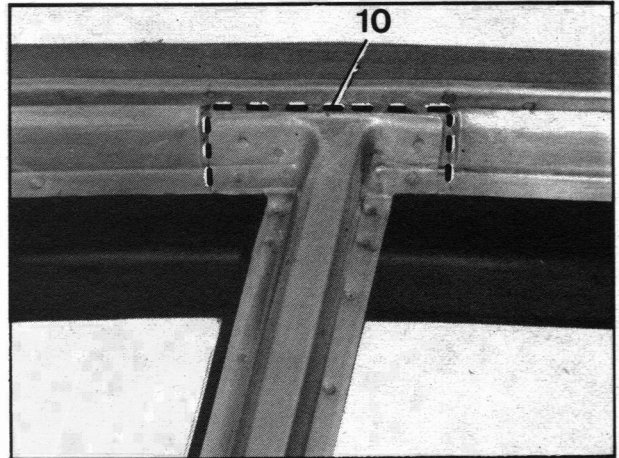

8218

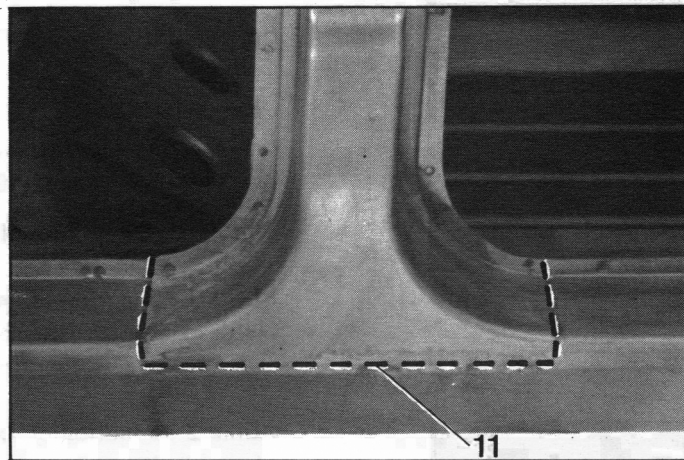

8219

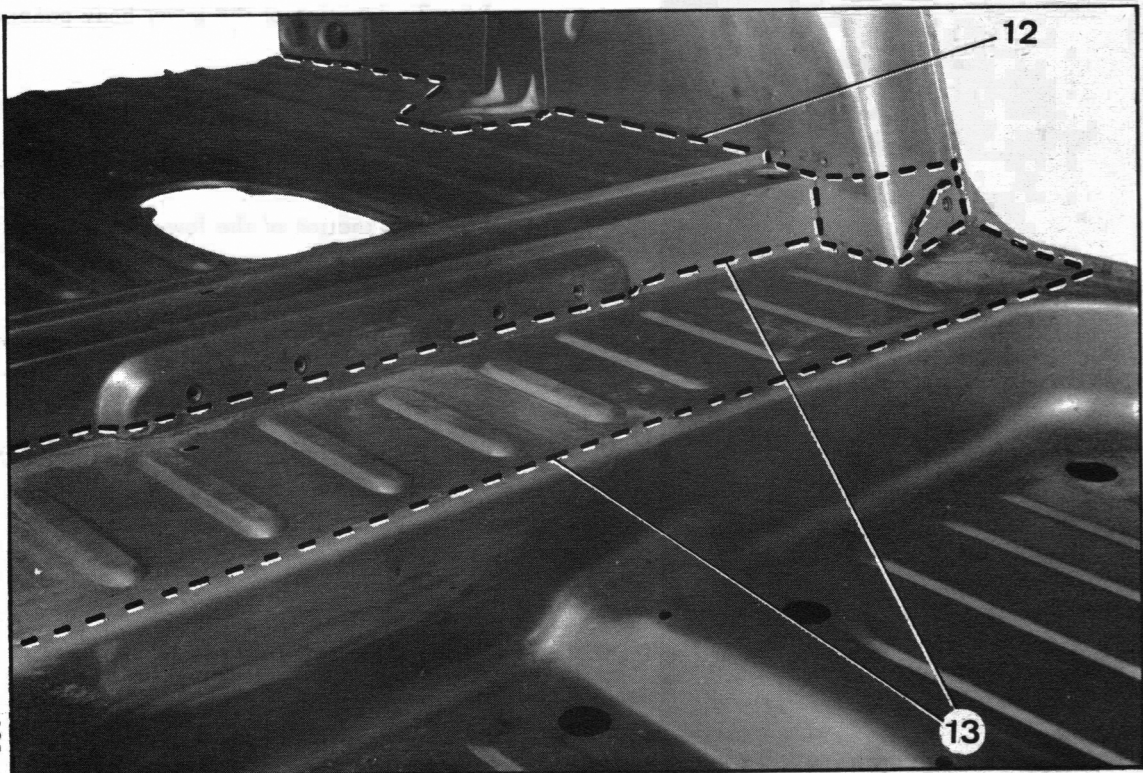

8260

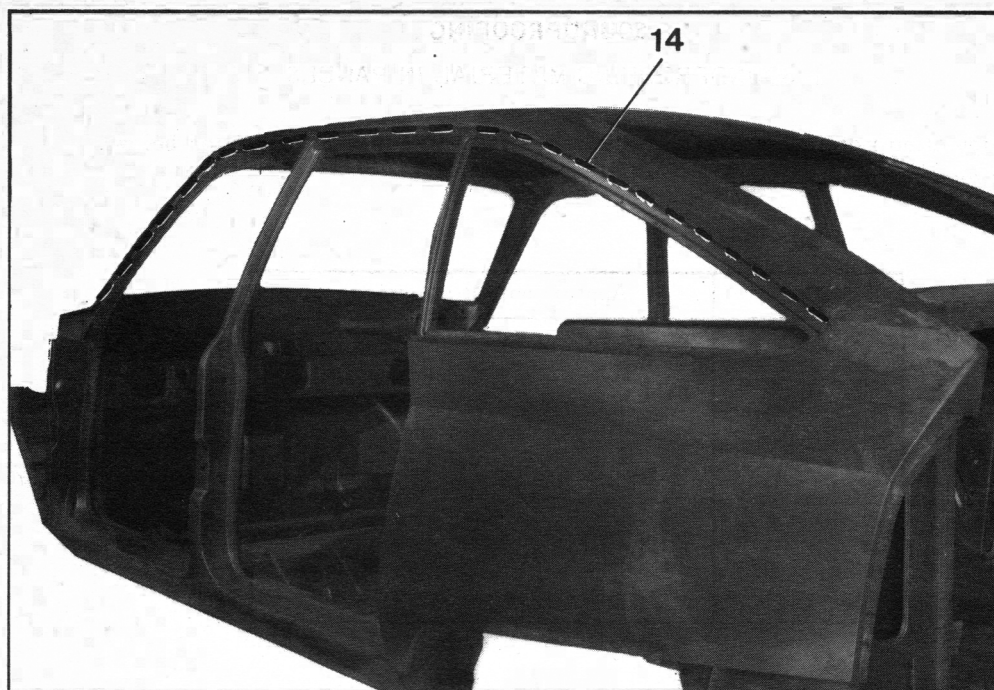

8209

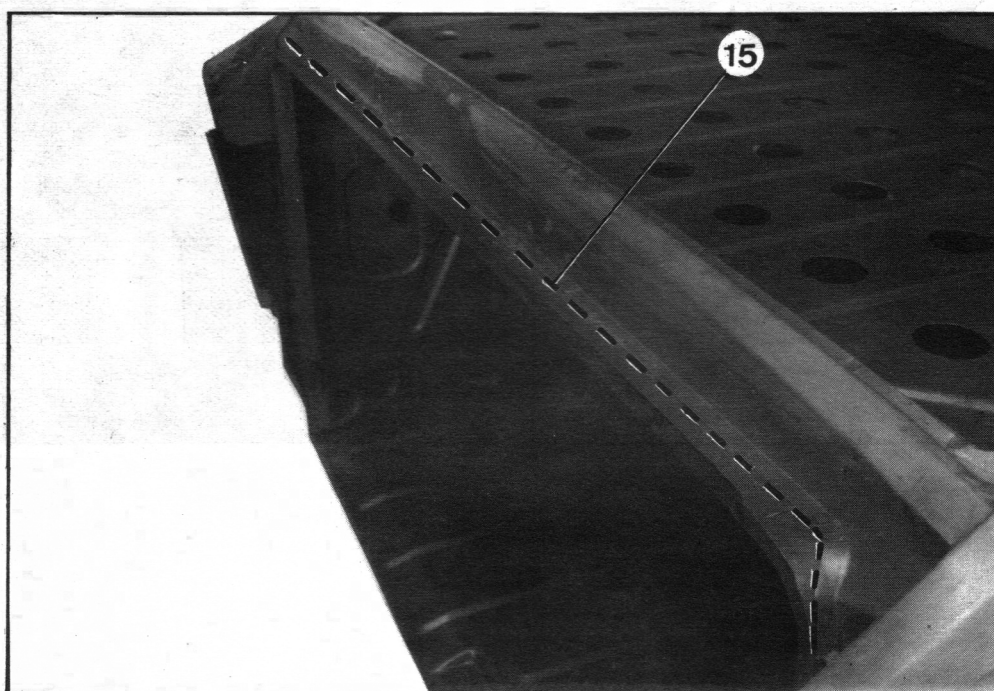

8256

- **Line 9** : Junction of the central pillar with the underbody, *inside and on each side.*
- **Line 10** : Junction of the central pillar with the cantrail of the roof, *on the inside and on each side.*
- **Line 11** : Junction of the central pillar with the underbody, *on the inside and at each side.*
- **Line 12** : Junction of the wheel arch with the boot floor, *on each side.*
- **Line 13** : Junction of the boot bottom with the underseat crossmember.
- **Line 14** : Junction of the guttering rail with the roof panel, *on each side.*
- **Line 15** : Junction of the rear parcel shelf with the lower roof crossmember.

## SOUNDPROOFING

### I. SOUNDPROOFING MATERIAL IN PANELS

Fit soundproofing material in panels in the zones indicated in the illustration below.  
Use only recommended products.

| Mark | Approximate dimensions    |
|------|---------------------------|
| a    | 200 × 550 mm openings not |
| b    | 200 × 570 mm included     |
| c    | 450 × 450 mm              |
| d    | 450 × 450 mm              |
| e    | 360 × 450 mm              |
| f    | 360 × 450 mm              |
| g    | 80 × 80 mm                |
| h    | 80 × 80 mm                |
| i    | 80 × 80 mm                |

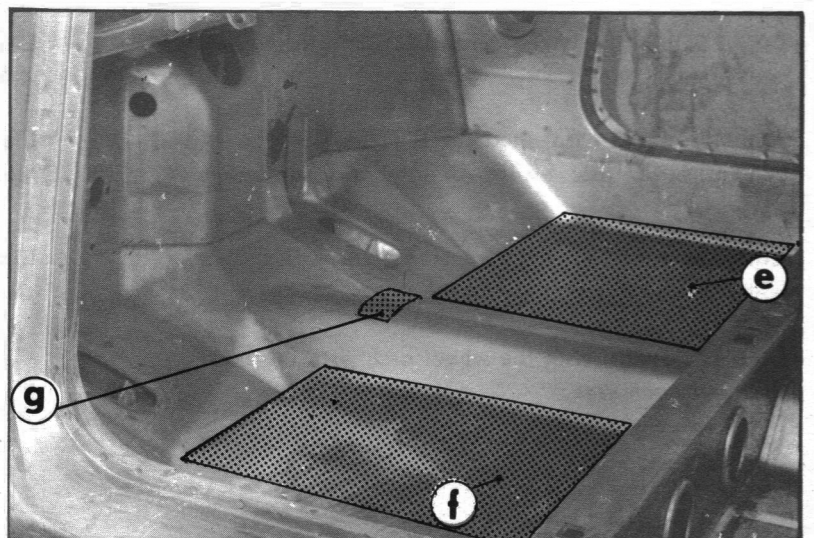
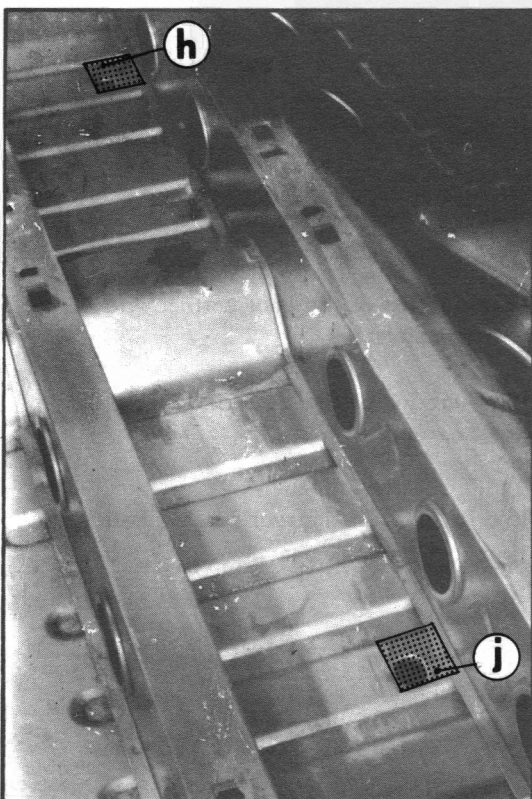
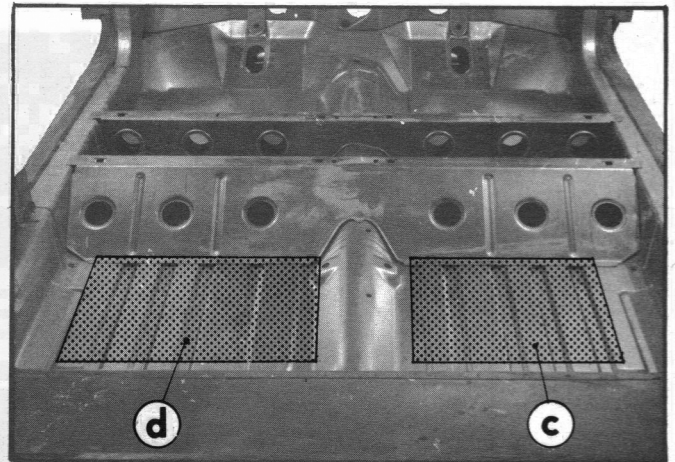
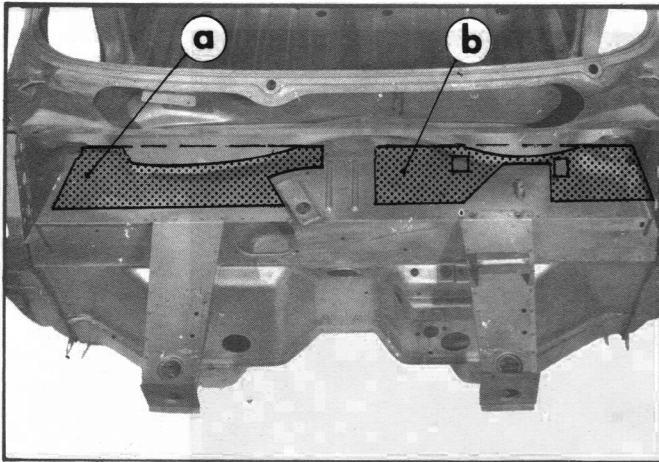



## II. SEMI-LIQUID, SOUNDPROOF AND PROTECTIVE COATING

For this operation, use only recommended products.

8222

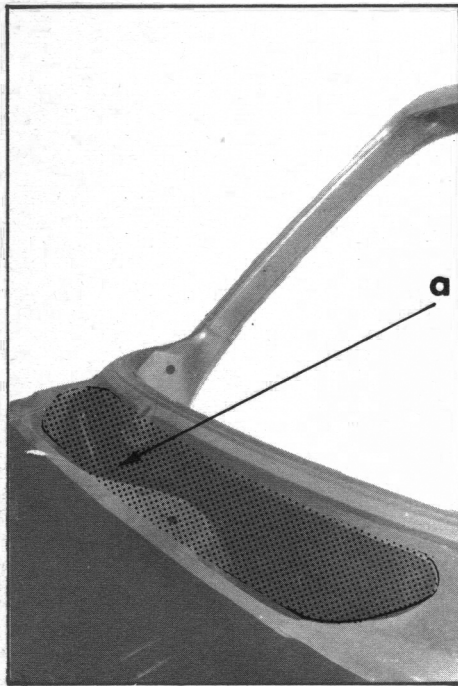

10651

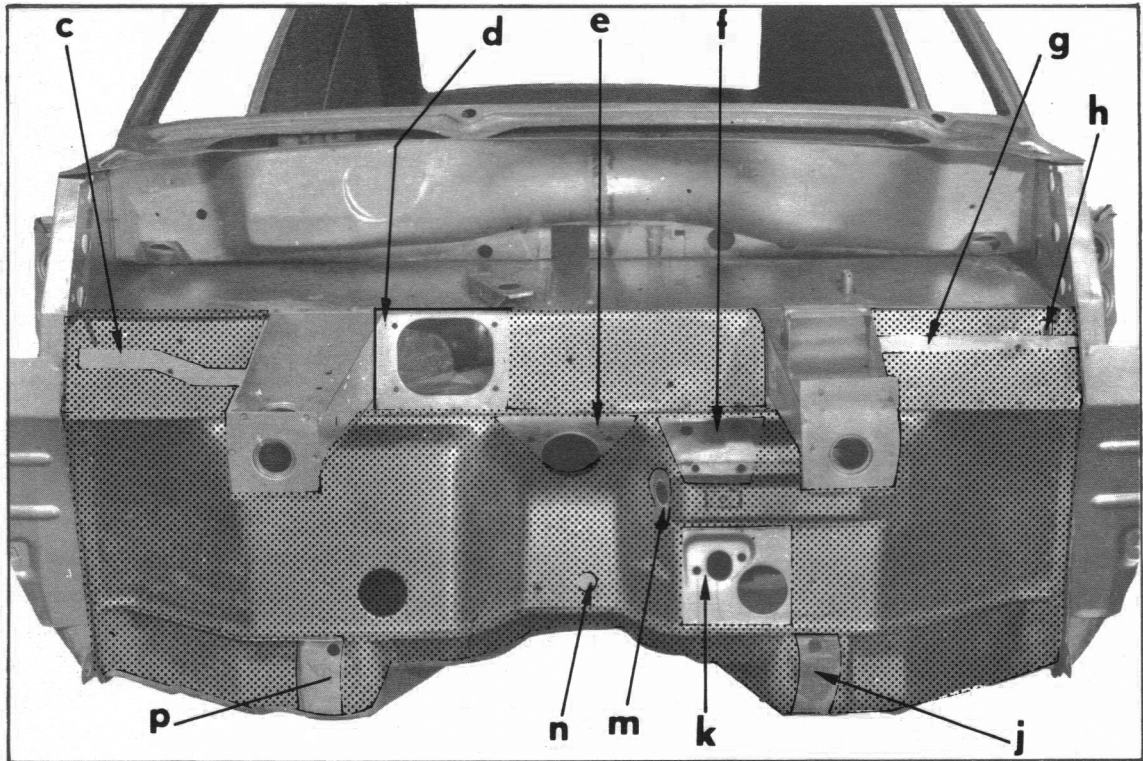
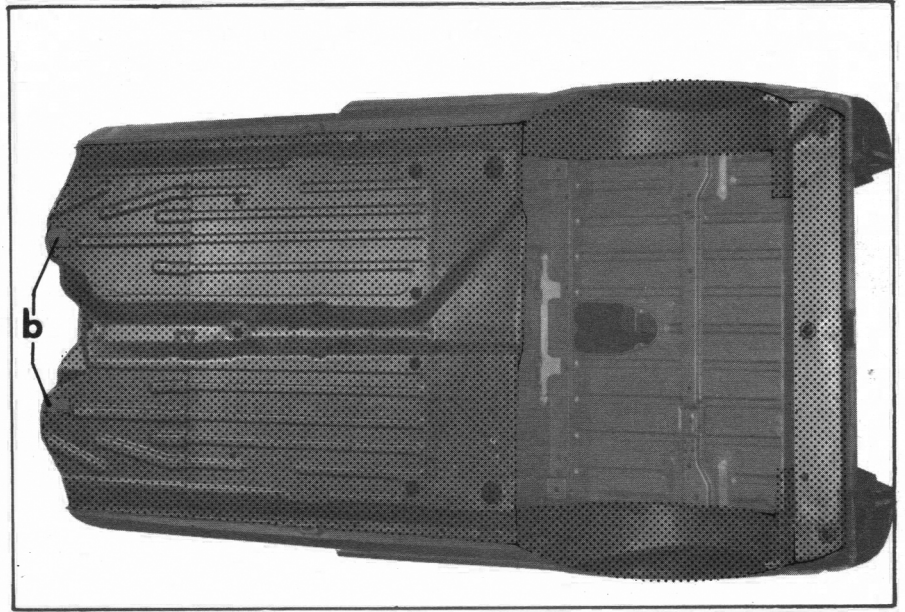

Apply the soundproofing products on the shaded zones shown in the above illustration.

**Figure 1 : The scuttle**

Before application mask the area where the windscreen wiper motor fits at « a ».

- the wheel arch mountings at « c » and « g »,
- the fan mounting at « d »,
- the gear lever opening at « e »,
- the foot pedal mounting at « f »,

**Figure 2 : The underbody, the rear wheel arches and the rear crossmember**

Before application, mask the areas « b » where the lower mountings of the front suspension unit fit.

- the opening for the bonnet control at « h »,
- the suspension unit mountings at « j » and « p »,
- the brake control valve mounting at « k »,
- the accelerator linkage opening at « m »,
- the access hole at « n ».

**Figure 3 : Front body panel**

Before application, mask :

## CHECKING A VEHICLE WITH ACCIDENT DAMAGE

When checking a vehicle with accident damage, the checks must be carried out in the following order :

- Visual check : finding the possible creases, distortions, splits or twists on the body unit.
- Checking the geometry of the axles using an optical alignment device ( without removing the mechanical components )
- Checking the front and rear axle units and the geometry of the body unit ( removing the mechanical components )
- Checking the stripped body shell on the jig and possible straightening.

### I. VISUAL CHECK

To facilitate finding the distortions, they have been classed in area of impact in ascending order depending on the force of the impact.

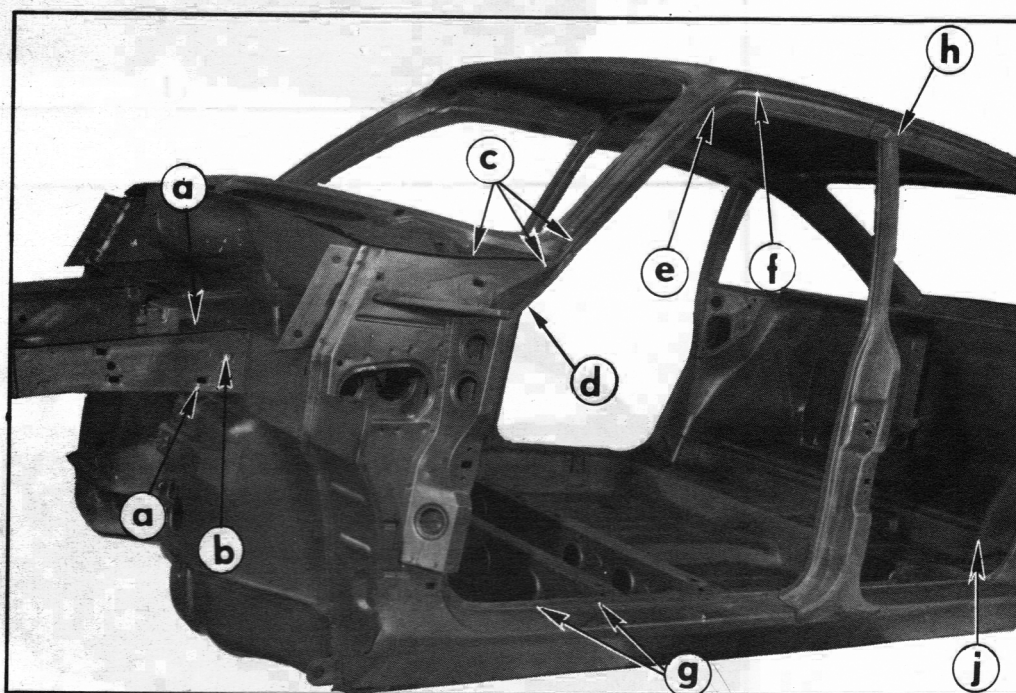

#### A - FRONTAL IMPACT

The distortions below are generally found on both sides of the body unit.

1. **Front extensions** : distortions at « a » on the upper and lower faces, always accompanied by side distortions at « b » near the scuttle.
2. **Lower windscreen crossmember** : indentation at joint « c » with windscreen frame.
3. **Joint between windscreen frame pillar and front door pillar** : Longitudinal indentations in the form of small creases at « d » on the side panel, level with the upper corner of the door.

#### 4. Roof sidemember :

Abnormal space between the upper part of the door, the windscreen pillar, and the sidemember. Creases at « e » and « f ».

5. **Body sidemember** : distortions at « g » between the joint with front door pillar and first crossmember under seats.

6. **Centre door pillar** : in the event of a strong impact, it may be separated from the roof crossmember at « h ».

7. **Heel board** : following a very severe impact, creases may appear at « j » on the heel board, situated under the rear seat.

IMPACT FRONT 3/4

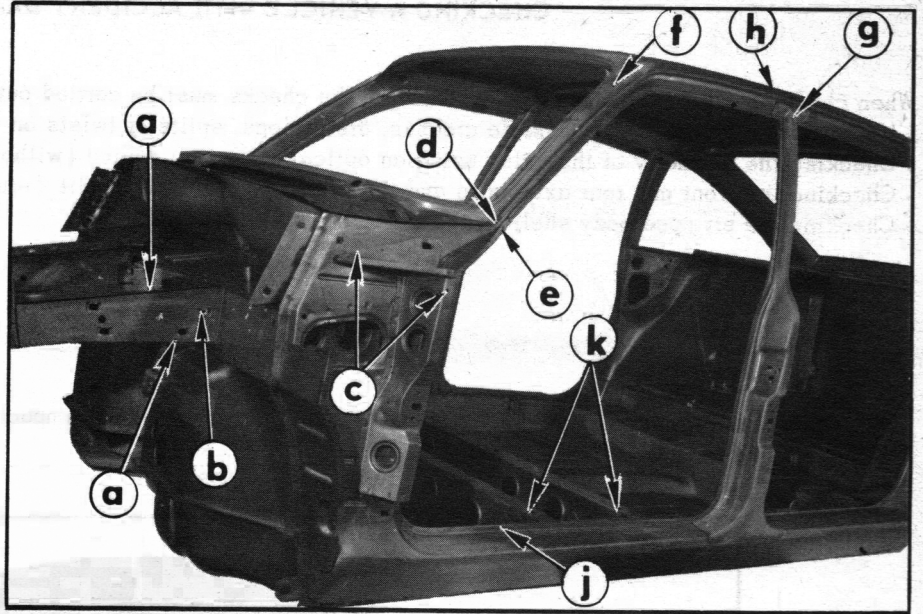

SIDE IMPACT

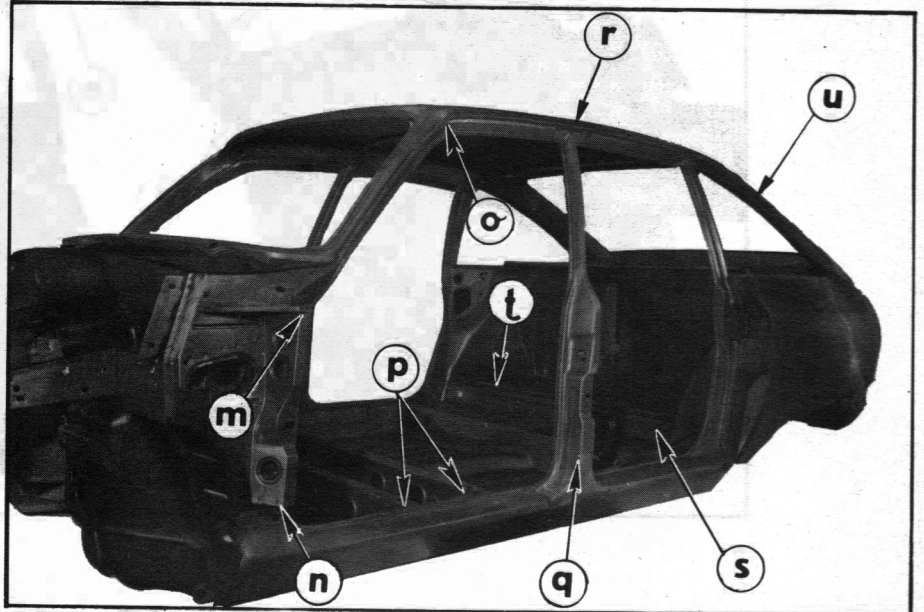

IMPACT REAR 3/4  
AND REAR

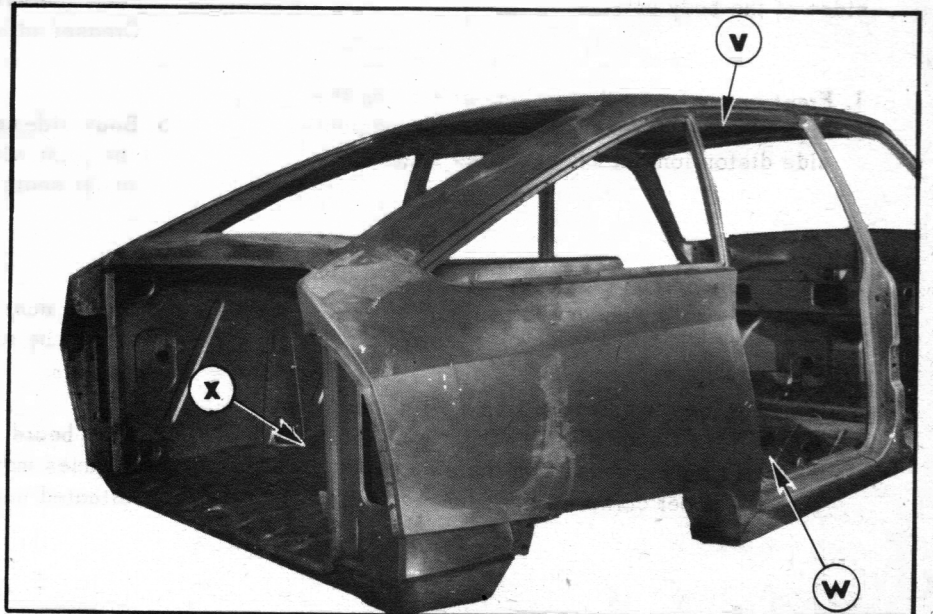

**B - IMPACT, FRONT 3/4**

1. **Front extensions** : Distorsions at « a » on the upper and lower faces, always accompanied by side distorsions at « b » near the scuttle.
2. **Hinge support and front pillar** : Indentation and pushing back of front pillar at « c » : the door is no longer in line with the side panel.
3. **Lower windscreen crossmember** : Indentation at « d » of front pillar upper part. This produces a distorsion of the lower crossmember and the windscreen frame itself. Splitting on the outer face of the frame, at the bottom, at « e ».
4. **Roof sidemember and windscreen frame pillar** : Presence of indentations at « f » of the solder filling linking the windscreen frame to the roof. Abnormal space between front door upper part and roof sidemember.
5. **Joint between roof and central door pillar** : Distorsion of roof at « g » with dent and fracture of roof edge at « h ». This can sometimes loosen the central pillar.
6. **Body sidemember** : Large creases at « j » on the sidemember and at « k » on the crossmember beneath the seats.

**C - SIDE IMPACT**

1. **Front door pillar and body sidemember** : Indentation at « m » on front pillar and at « n » on sidemember, with creases on the roof at « o » and the crossmembers beneath the seats at « p ».
2. **Centre pillar and body sidemember** : Indentation at « g » on the pillar and the sidemember with creases on the crossmembers beneath the seats at « p », loosening the central door pillar from the roof sidemember and with creases at « r » on the roof in the region of the joint with the centre pillar.
3. **Rear door pillar and rear wing** : Indentation on rear pillar, wings and wheel arch, with folds on the heel board at « s », on the rear floor at « t » and inner wheel arch. Splitting of the side panel and the roof at « u » above the rear quarter light opening.

**D - IMPACT 3/4 REAR OR REAR**

1. **Joint between roof sidemember and rear pillar** : Creases at « v » about 10 cm ( 4" ) in front of rear pillar.
2. **Joint between body sidemember and heel board** : Creases at « w ».
3. **Rear floor** : Creases at « x » between securing points of rear axle unit.
4. **Various components** : Local distorsions on side panel, rear crossmember, wheel arch, rear lamp plate, lower crossmember for rear window frame, etc...

**E - CONCLUSION**

If a visual inspection reveals obvious indentations or creases at the places indicated above, **a body jig must of necessity be used.**

On the other hand, if there is some doubt as to the extent of the indentations or creases, it is then essential to check the geometry of the axles, then the front and rear axle units.

**II. CHECKING THE GEOMETRY OF THE AXLES**

Refer to : Operation G. 410-0 for the front axle

Operation G. 420-0 for the rear axle.

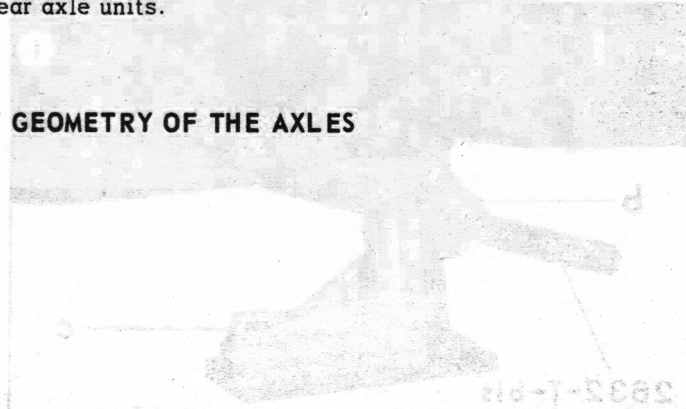

## III. CHECKING FRONT AND REAR AXLE UNITS

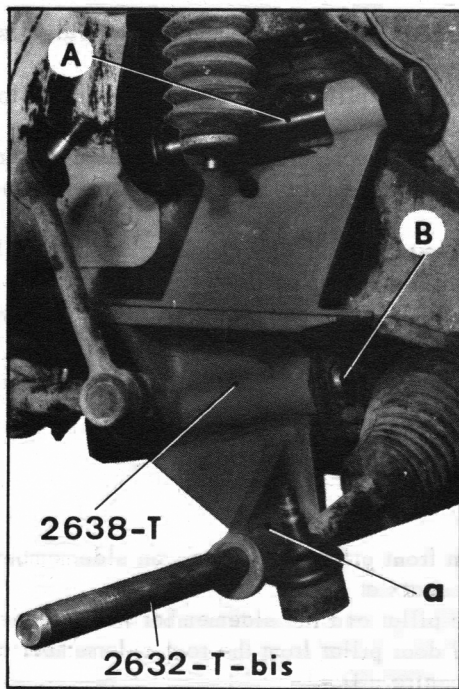

## 1. Checking the front axle unit :

- a) Put vehicle on stands and on a flat horizontal surface, remove from each side :
  - the upper and lower axle arms,
  - the drive shaft.
- b) On each side, offer up tool 2638-T at the securing points of the axle arms.  
Fix it, using :
  - an upper threaded spindle A : the knurled nut must be positioned towards the rear of the vehicle,
  - a lower spindle B : it must be free in its bore and the head must be positioned towards the rear of the vehicle.
- c) Introduce rod 2632-T bis into the lower bores « a » of the tools : it must be able to turn and slide smoothly.

If this is not so, the axle unit is buckled and must be replaced. However, as it is possible that the body itself is buckled, the body must be checked on a jig before fitting a new axle unit, this necessitates removing all the mechanical units ( in this case, the checks in § 2 to 4 are not required ).

**IMPORTANT :** In no circumstances must the axle unit be straightened.

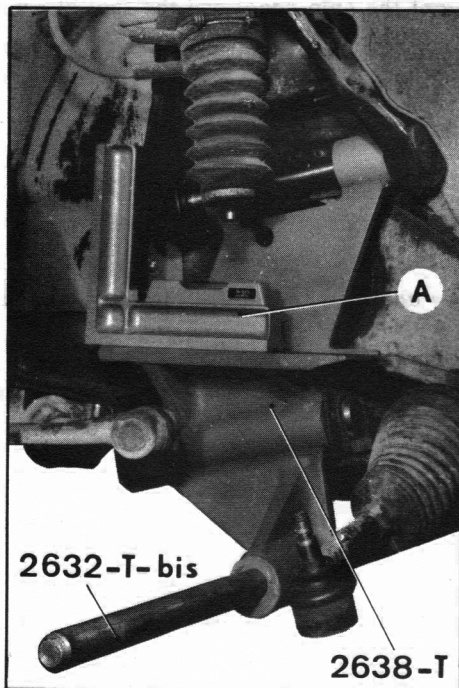

## 2. Checking rear axle unit :

- a) Put vehicle on stands and on flat horizontal surface, remove from each side :
  - the axle arm,
  - the forward suspension buffer.
- b) On each side, position tool 2637-T on the axle arm shaft.
- c) Position spirit level C on the foot of one of the tools 2638-T positioned at the front : adjust the bubble to « zero »
- d) Position the spirit level C on the foot of each of the tools 2637-T positioned at the rear : using screw (1), adjust the position of each of them so that the spirit level bubble is at « zero ».
- e) Introduce rod 2632-T bis in the lower bores « b » of tool 2637-T bis : it must be able to turn and slide smoothly.

If this is not so, the axle unit is buckled and must be replaced : in addition this will allow checks to be made to determine whether or not the body itself is buckled.

**IMPORTANT :** In no circumstances must the axle unit be straightened.

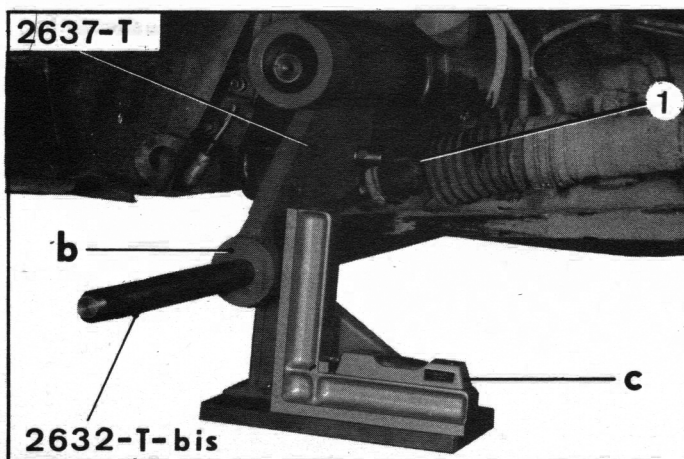

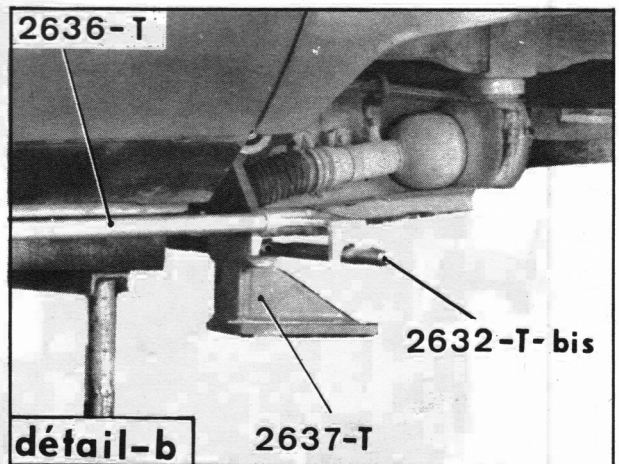
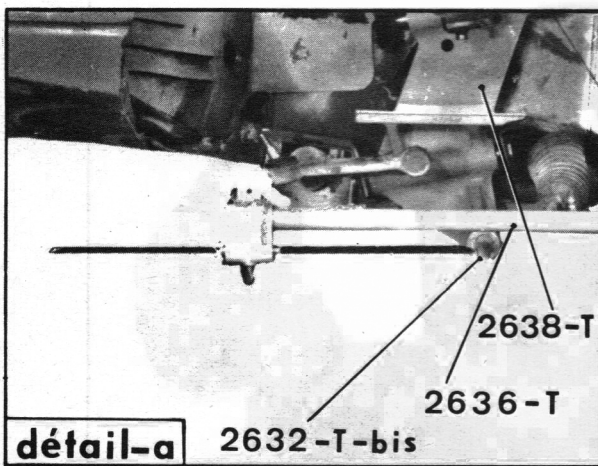
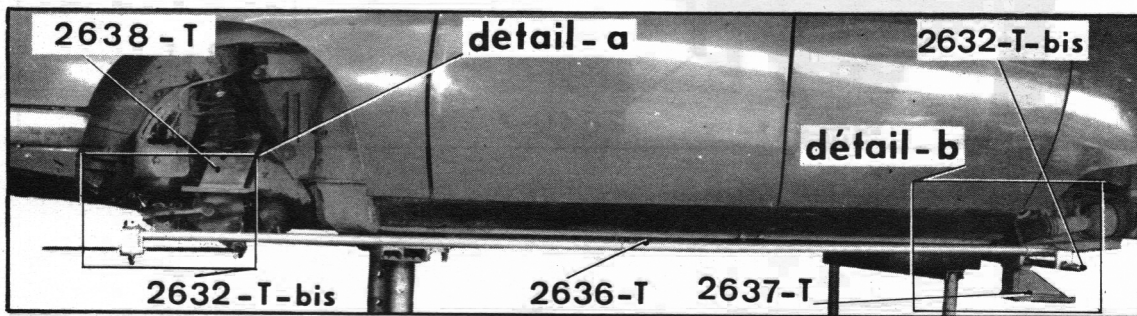
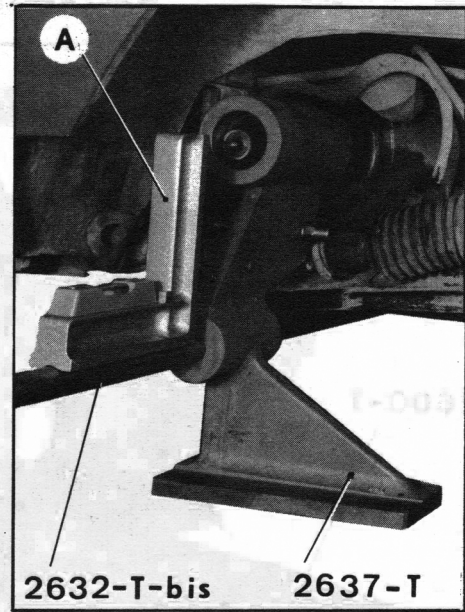
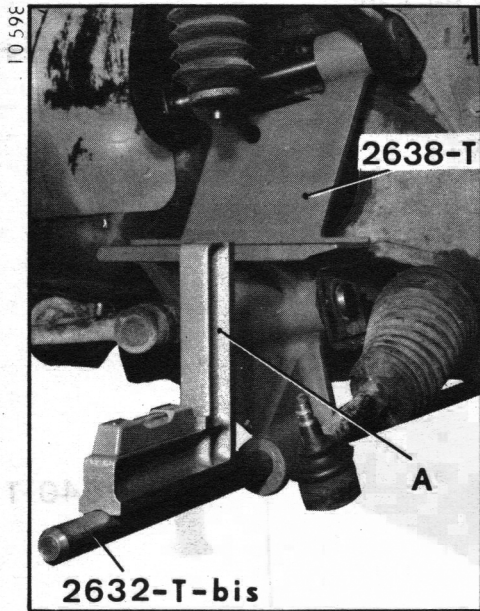

**3. Checking for « twists » on the body :**

NOTE : This check is to be carried out when checks on the axle unit have not revealed anything unusual.

- a) Position the adjustable spirit level A on each of the rods 2632-T bis at the front and rear in succession.
- b) Check that the two rods are horizontal to within 0.25 % ( e.g. with a 300 mm long spirit level the difference measured with feeler gauges must not exceed 0.75 mm ).

**4. Check that the axles are parallel :**

Offer up gauge rod 2636-T successively on each side of the vehicle.

Position the foot of this gauge on one of the bars 2632-T bis and bring the adjustable end into contact with the bar at the other end of the car. Choose the side where the distance between the two bars is greater, and adjust the end-piece. Compare it with the other side : with the help of feeler gauges, take note of the difference, which must not exceed 4 mm.

NOTE : If the results of the last two checks are not correct, you must remove the front and rear axle units in order to be able to carry out the checks on the body jig.

## IV - CHECKING A BODY ON A JIG

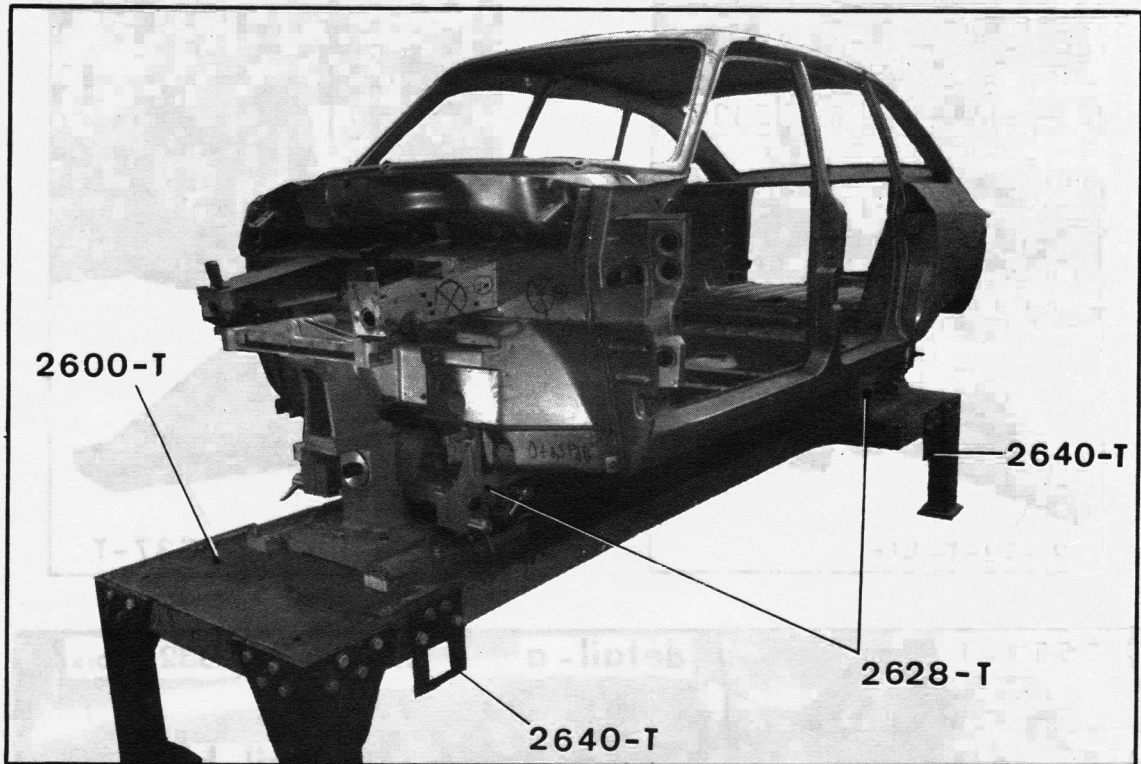

FENWICK : « GS » EQUIPMENT : 2828-T  
ON JIG : 2600-T

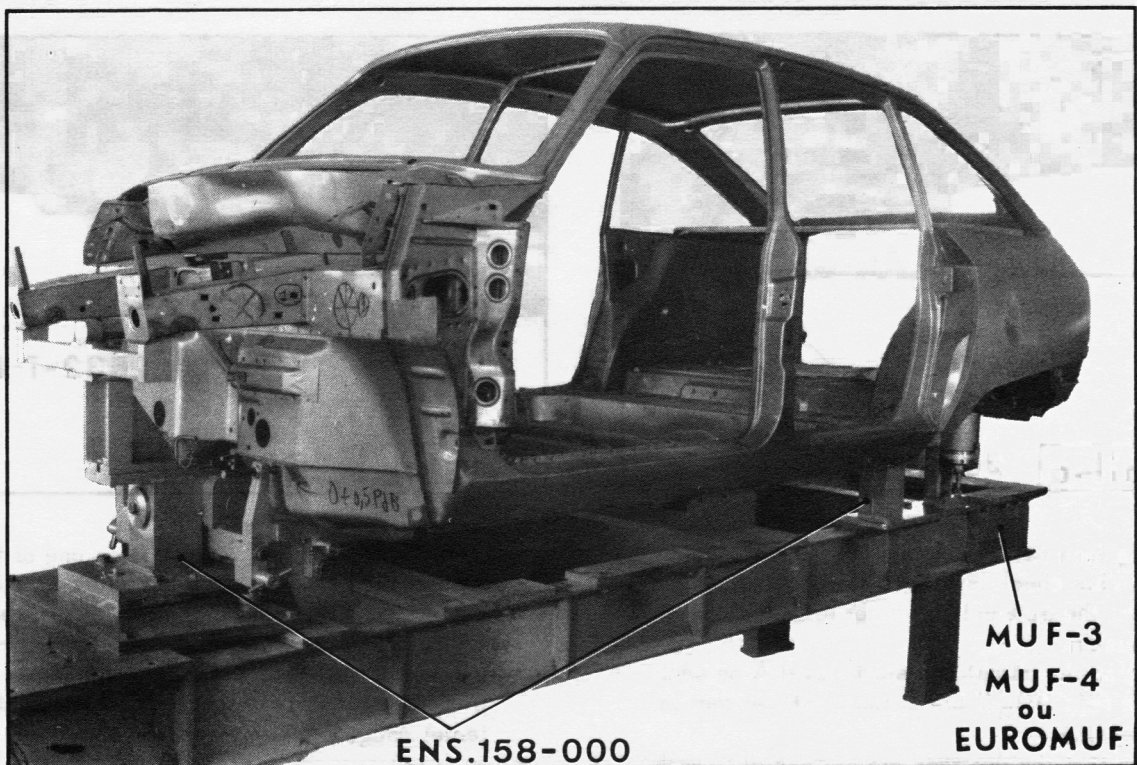

CELETTE : « GS » EQUIPMENT : ENS. 158-000  
ON JIG : MUF. 3 MUF 4 or  
EUROMUF

FENWICK EQUIPMENT

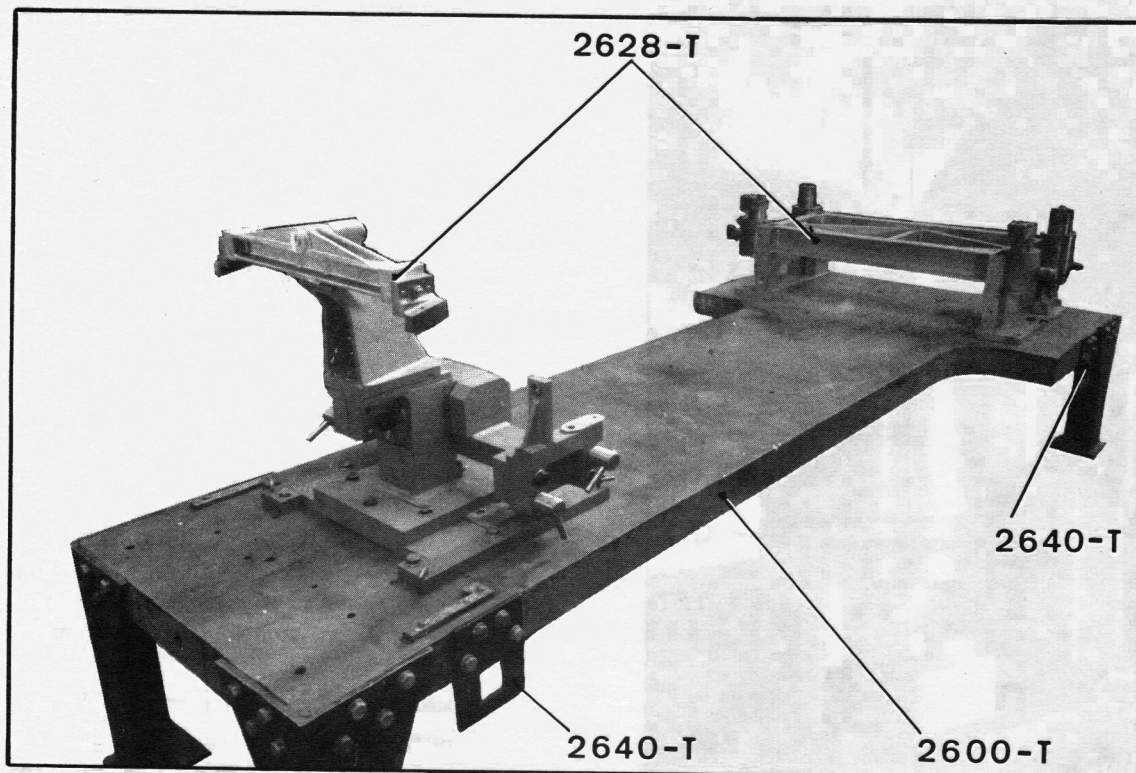

CELETTE EQUIPMENT

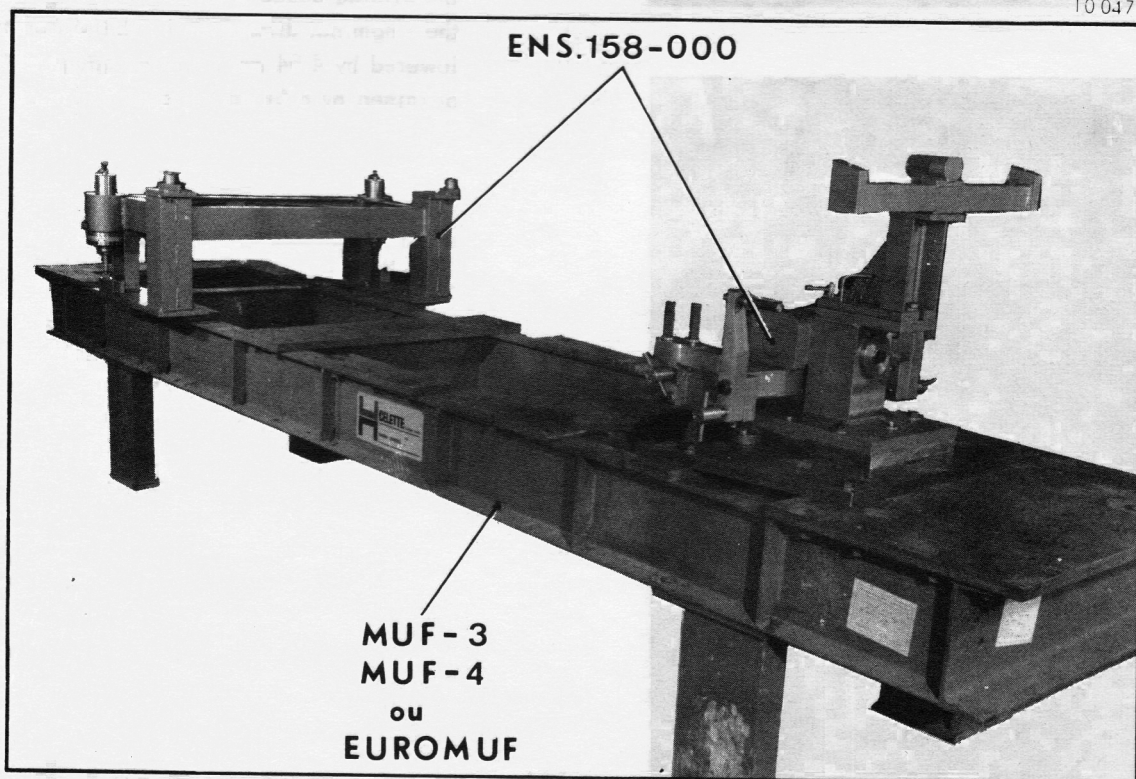

DESCRIPTION

Both sets of equipment are made up of two assemblies ( front and rear ).  
Their construction is such that jacks may be used to straighten the body while it is on the jig.



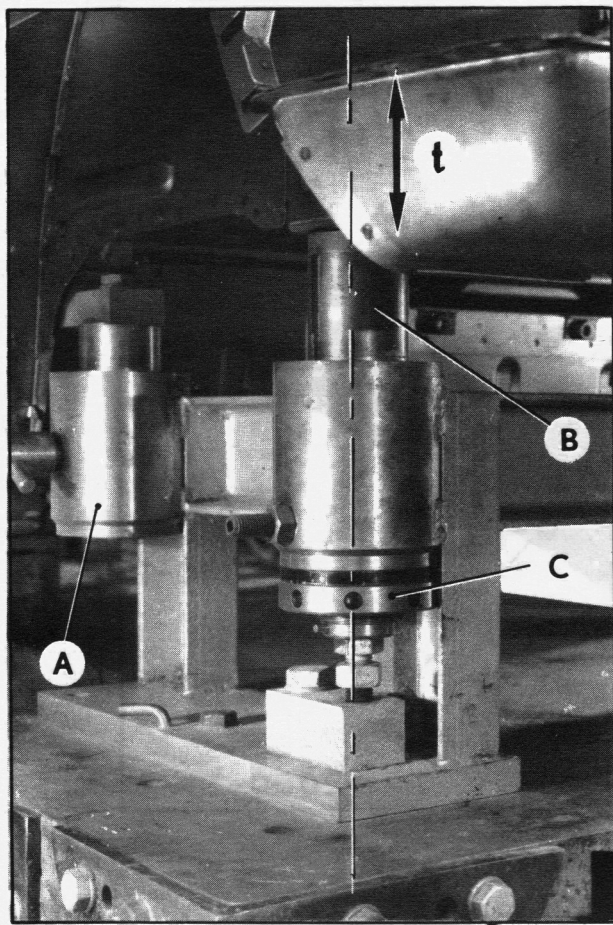

### 1. Rear assembly :

The body is held in position at four points which are the securing points for the rear axle unit :

- the two front points ( bobbins or supports A ) are fixed.
- the two rear points ( pistons B ) can move on a vertical centreline : a sliding gauge C, an integral part of each piston B, allows the position of the rear securing points to be checked within the limits of a permissible tolerance « t ». When the sliding gauge C is at « zero », piston B is at the « nominal dimension » : the piston may be lowered by 4.64 mm ( sliding gauge at « - 4.64 » ) or raised by 8.64 mm ( sliding gauge at « + 8.64 » ).

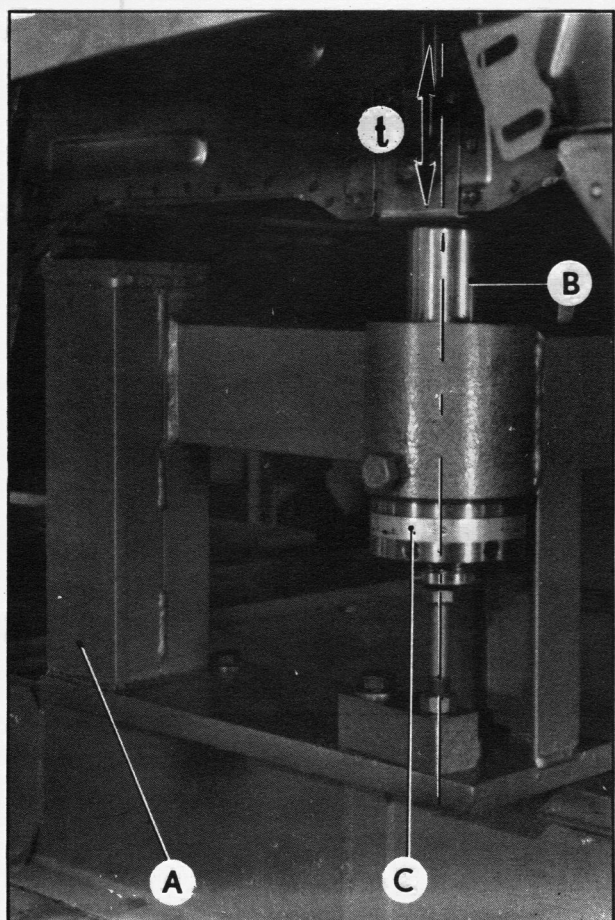

## FENWICK

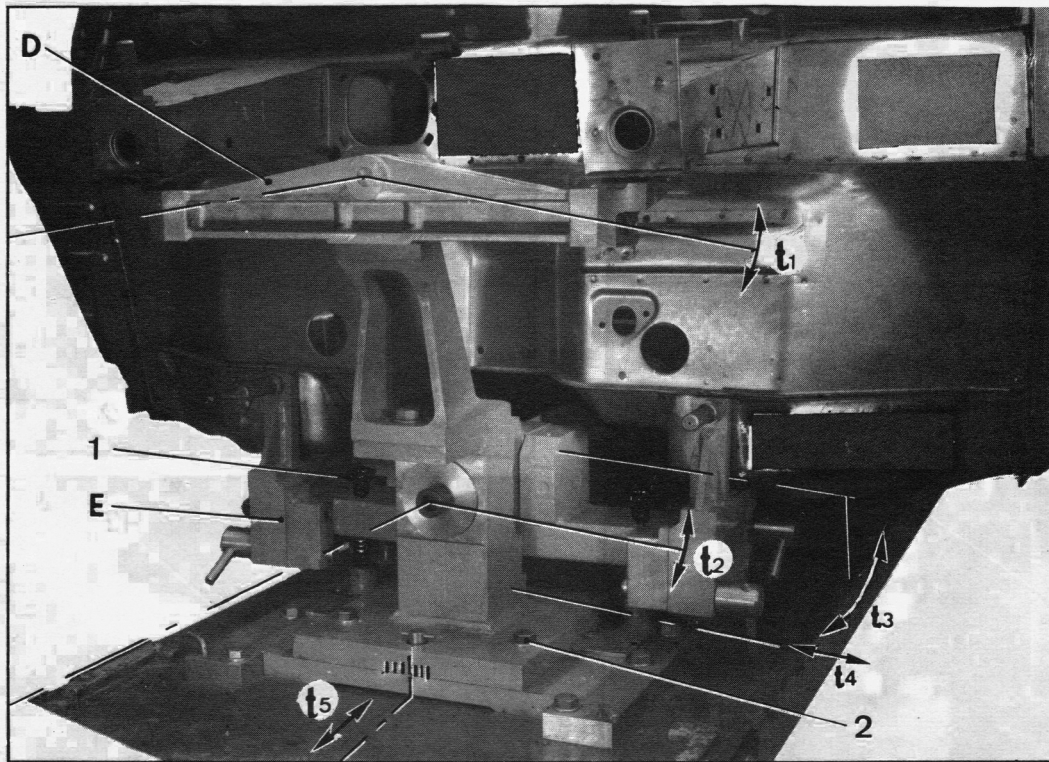

## CELETTE

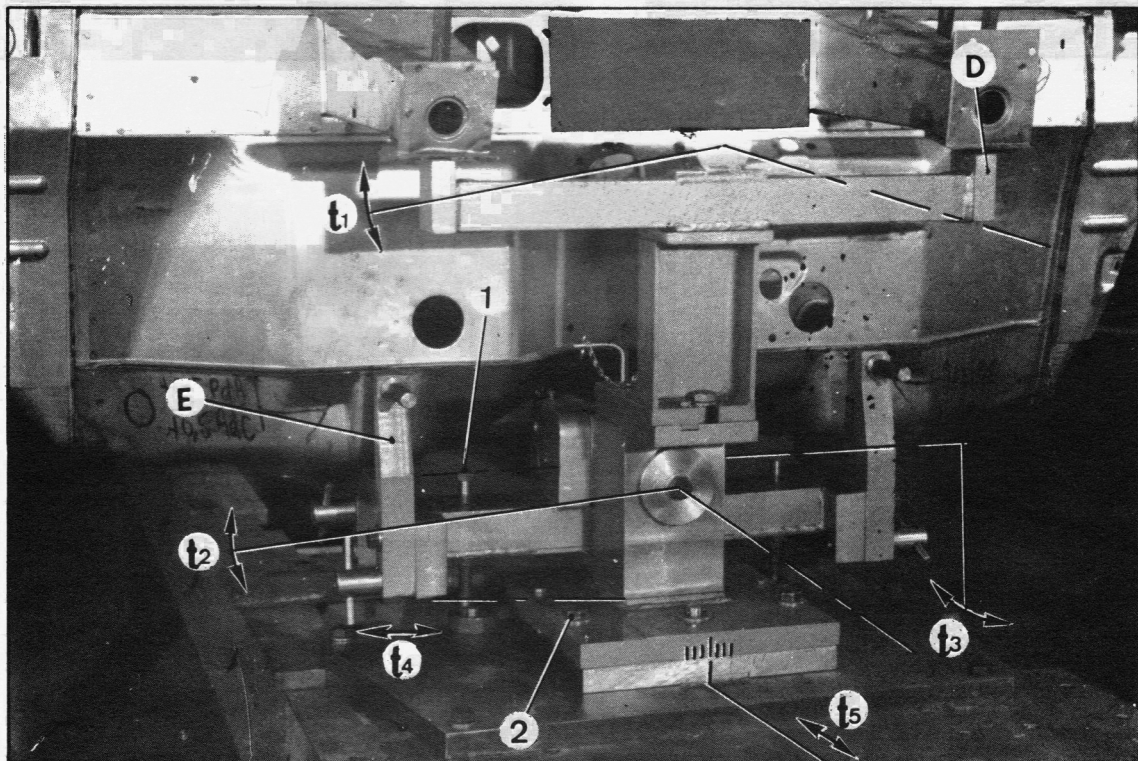

**2. Front assembly :** The body is located at eight points, which are the securing points of the front axle unit.

This assembly is movable with regard to the body jig and provides for :

- a fore-and-aft tolerance « t5 »,
- a sideways tolerance « t4 »,

when the two screws (2) have been slackened.

Two supports on this assembly are movable, which allows in addition :

- for the upper securing points : - tolerance « t1 » ( transverse rocking of extension support D ),
- for the lower securing points : - tolerance « t2 » ( transverse rocking of lower support E ) when the two screws (2) have been entirely slackened )
- tolerance « t3 » ( longitudinal rotation of lower support E ).

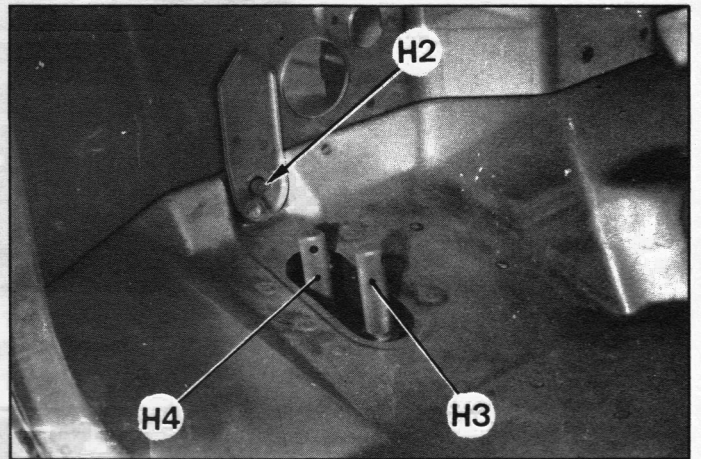
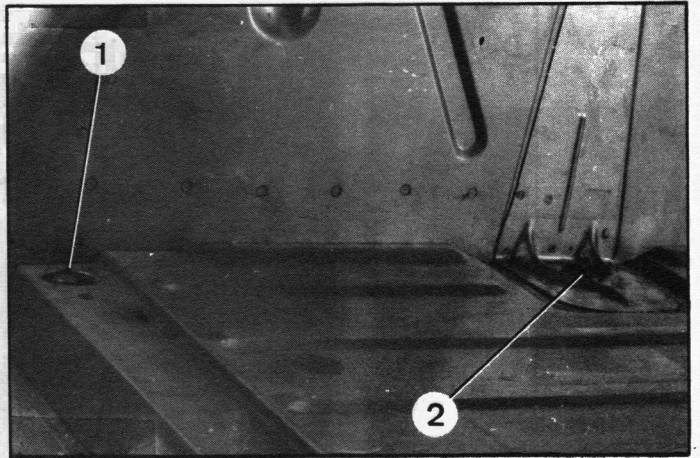
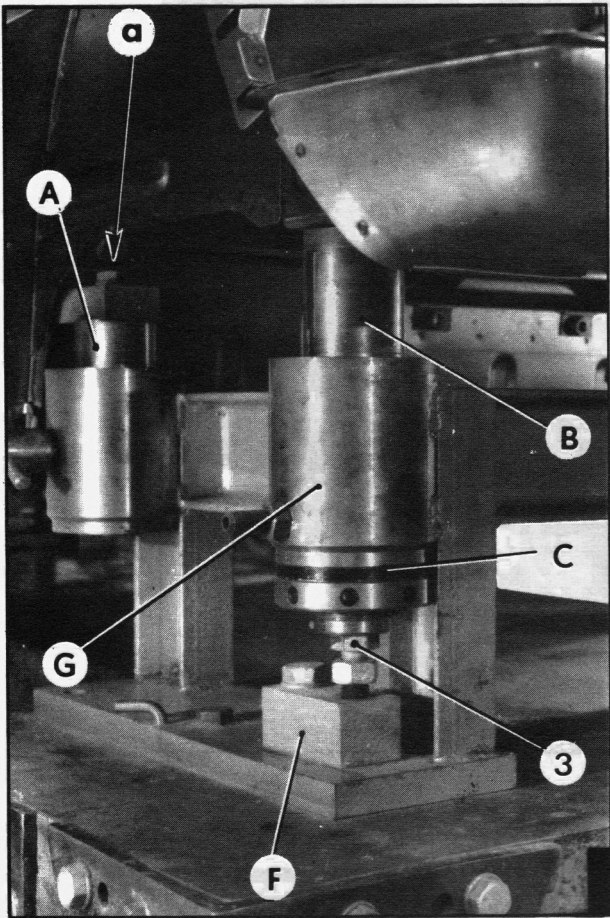

9804

FENWICK

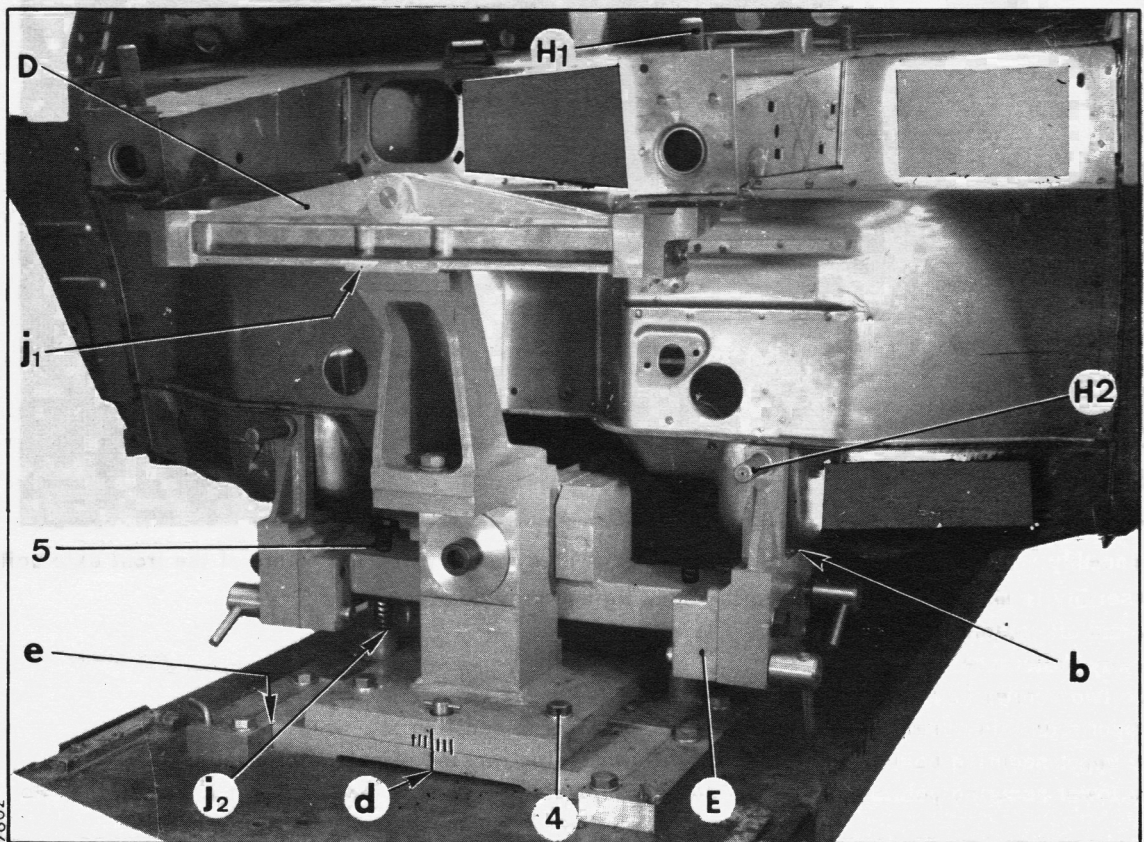

9802

**FIRST CASE : Slightly damaged body****1. Check rear securing points :**

- a) Lower pistons B of rear assembly as far as possible by operating the screws (3).
- b) Offer up the body horizontally above the jig :
  - Let it rest on the two front bobbins A ( or supports ) of the rear assembly.
  - Engage the body at « a » on the centring dowels of the bobbins. **Do not fit the securing screws.**
- c) Rest the body on the front assembly of the jig.
- d) On each side of the rear assembly completely slacken sliding-gauge C.
- e) *Check :*
  - that the body is in contact with each of the supports of the front assembly at « b ».
  - that when operating the screw (3), each piston B can be brought INTO CONTACT with the intermediate crossmember : take care not to raise the body at « a ».
  - that the sliding-gauges C can be tightened until they make contact with cylinders G.
  - that the difference between the two distances shown by the sliding-gauges C is not greater than 4 mm.

IF ONE OF THESE CONDITIONS IS NOT FULFILLED, THE BODY IS BUCKLED.

NOTE : Examples of possible readings on the sliding-gauges.

- If one of the gauges shows « - 2 », the other must not have a reading greater than « + 2 ».
- If one of the gauges shows « + 4 » the other must not have a reading less than « 0 », nor greater than « + 8 ».

**2. Check the front securing points :**

- a) Slacken the two stop screws (4).  
Slacken the two screws (5) to bring them to the stop in the high position (maximal tolerance «t2»).
- b) On each side, position in order, rods H4, H3, H2 and H1.  
NOTE : This rod must be able to be engaged or screwed in by hand.
- c) Tighten again the two stop screws (4).
- d) *Check :*
  - that ALL the H rods can be removed BY HAND
  - that the clearance read at « j2 » (on the right or on the left) is not more than FIVE TIMES the value read at « j1 » on the same side.

IF ONE OF THESE CONDITIONS IS NOT FULFILLED, THE BODY IS BUCKLED.

NOTE : **Never jack a body while it is held in position on support D of the extensions.**

**SECOND CASE : Body damaged at the front****1. Fix the body on the rear assembly**

- a) Lower pistons B of rear assembly as far as possible by operating the screws (3).
- b) Offer up the body horizontally above the jig :
  - Let it rest on the two front bobbins A ( or supports ) of the rear assembly.
  - Engage the body at « a » on the centring dowel pins of the bobbins.
- c) Rest the body on the front assembly of the body jig.
- d) Raise pistons B ( screws (3) ) to the « nominal distance » (sliding gauge at «zero»).
- e) Fit the two screws at (1) and the two at (2).

**2. Place the front assembly at the « nominal distance » :**

- a) Remove the support D from the extensions. If necessary, remove one of the «brackets» of support E from the side on which the force is to be exerted.  
Slacken the two stop screws (4).  
NOTE : **Never «jack» a body while it is held in position on support D of the extensions.**
- b) Locate the front assembly in the « middle » position of all the permissible clearances :
  - *Side clearance «14» :* the «zero» of the sliding-gauge at « d » must be in line with the fixed mark.
  - *Longitudinal clearance «15» :* on FENWICK body jig : position a 2 mm thick shim at each side at « e » on CELETTE body jig : the corresponding sliding-gauge must be in the «zero» position.
  - *Rocking tolerance «12» of lower support E :* Slacken fully the two screws at (5). Position a 2.7 mm thick shim at «j2» under one of the screws (5) and tighten the other in such a way to take up the remaining rocking clearance.  
Withdraw the 2 mm thick shim and tighten this screw to take up the remaining rocking clearance of support E.  
Tighten the two screws (4).

**3. Straighten the body : « Jack » it until you can insert in order rods H4, H3 and H2 corresponding to the bracket which is still in position.**

NOTE : The rods must be able to be inserted by hand.

**4. Fix the bracket which has been removed.**

Follow the instructions in paragraph 3 above.

**5. Fit the support D for the extensions.**

Check the extensions using rods H1.

Proceed as indicated in § 2 d for the first case.

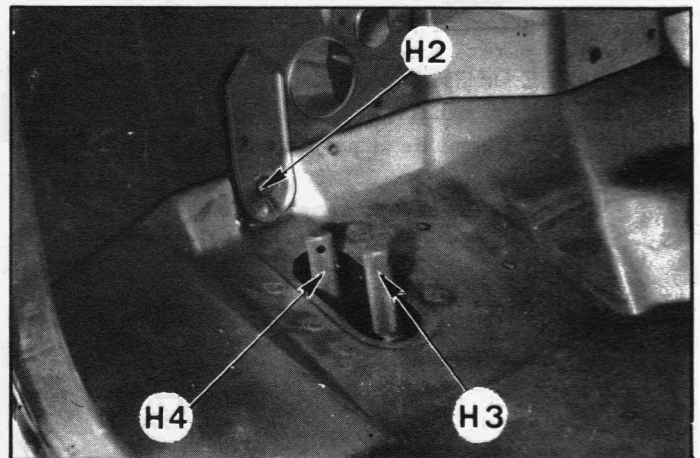
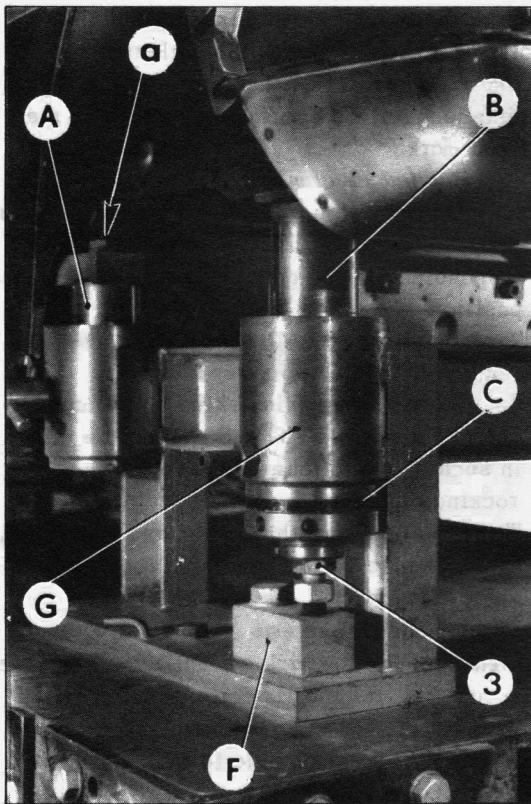
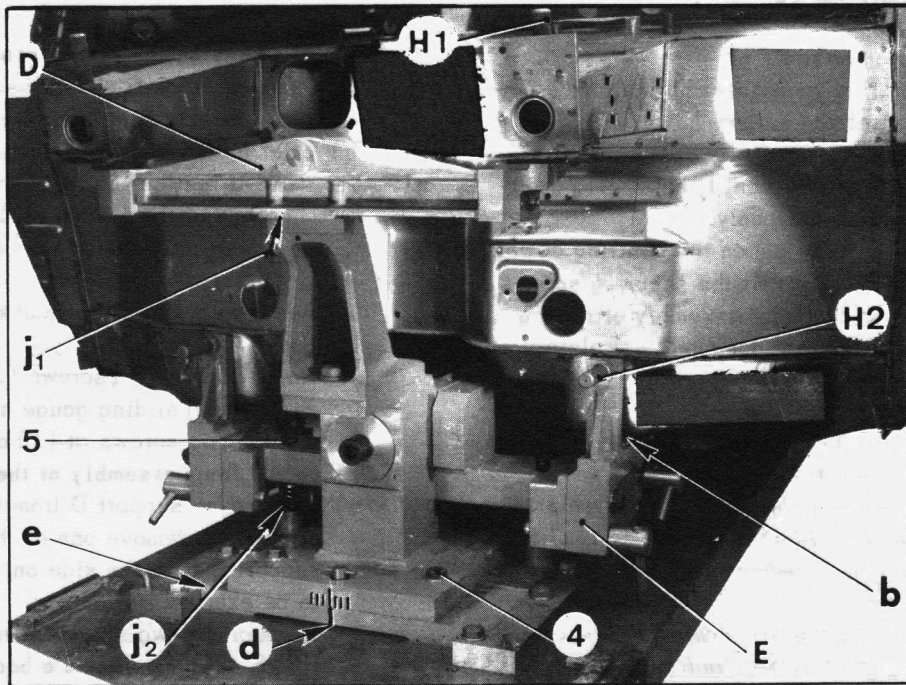

### THIRD CASE : Body damaged at the rear :

1. Position the front assembly at the « nominal distance » :  
Proceed as indicated in § 2 b of the second case.

2. Hold the body on the lower support of the front assembly with rods.

On each side, position rods H4, H3 and H2 in order.

NOTE : These rods must be able to be inserted by hand.

Check the extensions using rods H1, proceeding as indicated in § 2 d for the first case.

Withdraw the rods after the check.

3. Free the rear securing points :

Pivot shims F, and lower pistons B as far as possible.

4. Straighten the body : « Jack » it until you can check the rear securing points as indicated in § 1 on the first case.

**V - CHECKING THE DIMENSIONS OF A BODY**

The basic diagram below is only a guide.

In no circumstances can it be used as a reference when re-assembling a body.

Manual 810-2

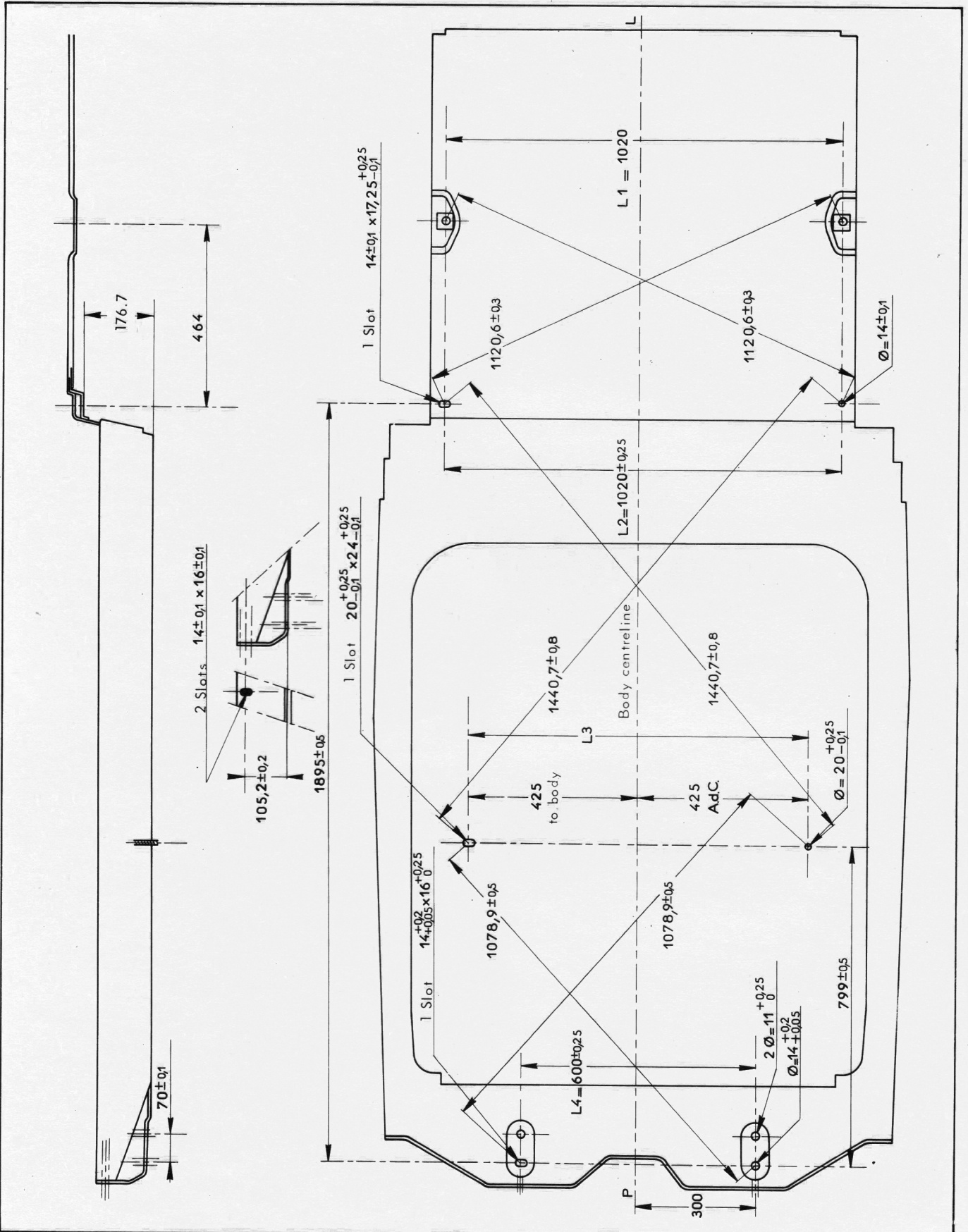

## REPLACING A TRIPLEX WINDSCREEN

NOTE : Whenever work is carried out on a windscreen , under no circumstances must metal tools such as, (screw-drivers, hooks etc... ) be used, as these would scratch the glass and damage the rubber sealing strip and trimmings. Use the tapered down end of a piece of hard wood to replace these tools.

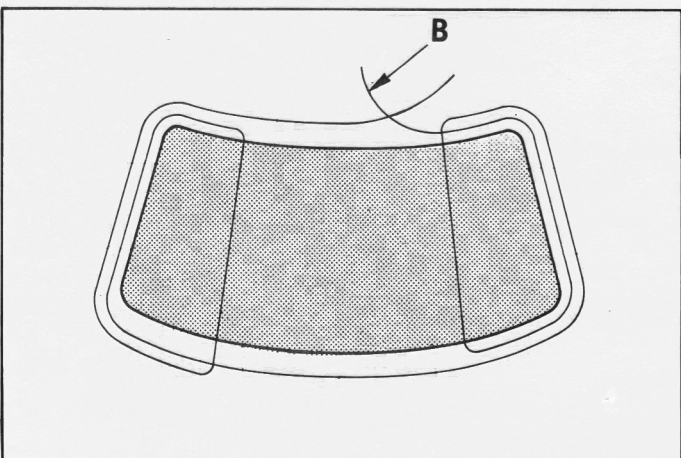
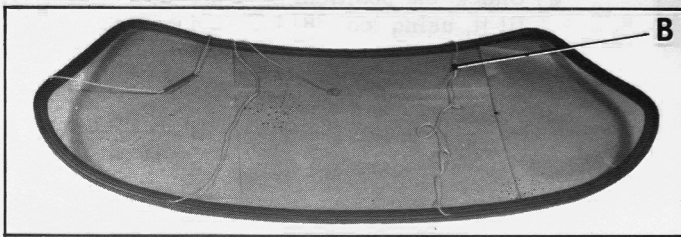
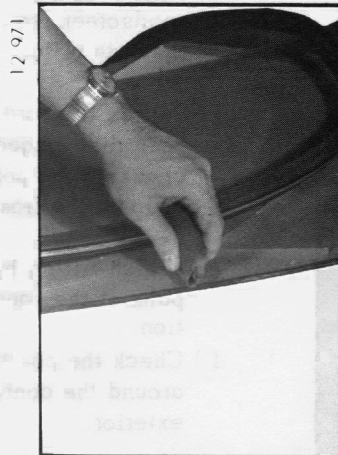
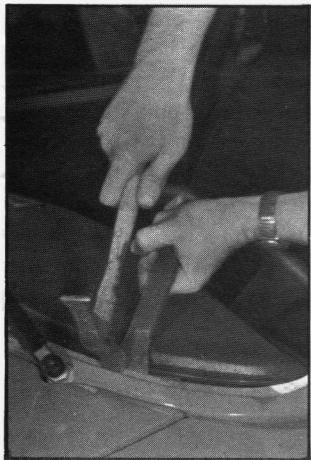
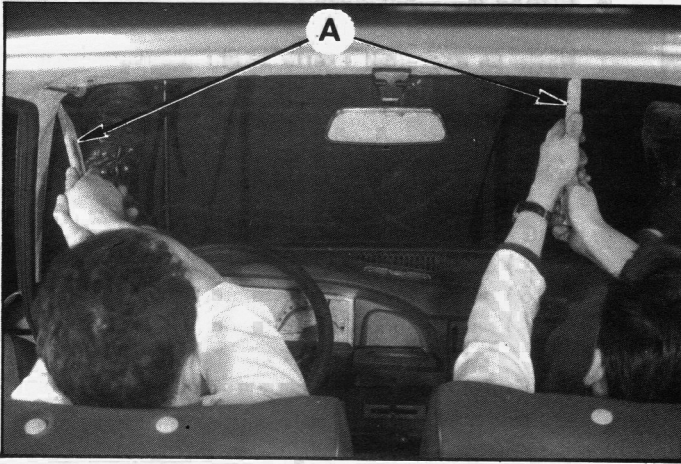

### REMOVAL

1. Raise the windscreen wiper blades
2. Removing the windscreen glass and its rubber sealing strip :

With the help of an assistant, sit in the vehicle, and place one foot on the windscreen and apply slight pressure. Assist the disengagement of the sealing using the tapered down end A of the piece of wood, starting at the two upper angles. Continue to disengage it along the upper part of the windscreen.

Disengage the windscreen from its frame with the rubber sealing strip and its setting strip.

### PREPARATION

3. Checking the windscreen frame :

If necessary, straighten out any deformations of the windscreen frame, file down any spot welds. Carefully stick down the roof trimmings. Check the curve around the windscreen frame (use the glass as a guide). Rectify the frame if necessary.

4. Checking the windscreen glass :

a) The contour must not have any rough edges if this is so, rub down with sandpaper 260 and water, proceed by small quick strokes, perpendicular to these, by hollowing and rounding off the edges. Wash with water, and rub down carefully.

b) Look for any visibility defects.

5. Fitting the rubber sealing strip on the glass :

Smear the sealing channels with liquid soap, fit it on the glass, place the abutting joint on the lower part of the windscreen, and in the centre-line of the vehicle.

Fit the rubber sealing setting strip using tool 3814-T with its abutting joint on the upper part of the windscreen, and in the centre-line of the vehicle.

6. Insert a piece of cord B 4 mm in diameter, in the groove of the rubber sealing, as shown in the diagram opposite.

NOTE : The double turn of the cord in the side pillars, allows, the glass when fitting to keep its complete flexibility, thus avoiding, due to its double turn, the use of a hook, in the case where the rubber sealing might have been badly positioned during the first turn of the cord

G. 96-2

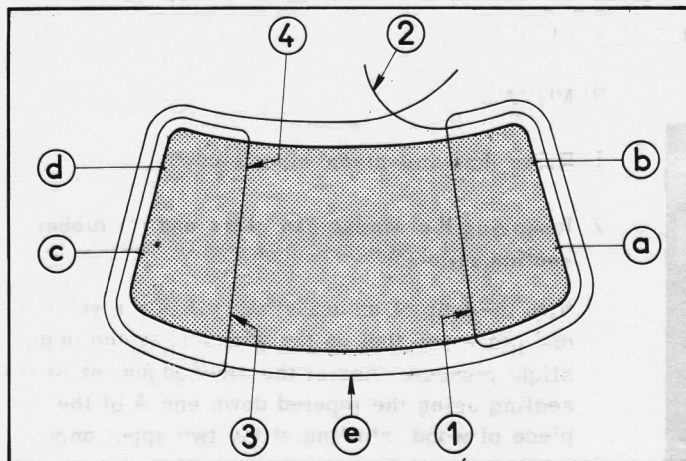

12 903

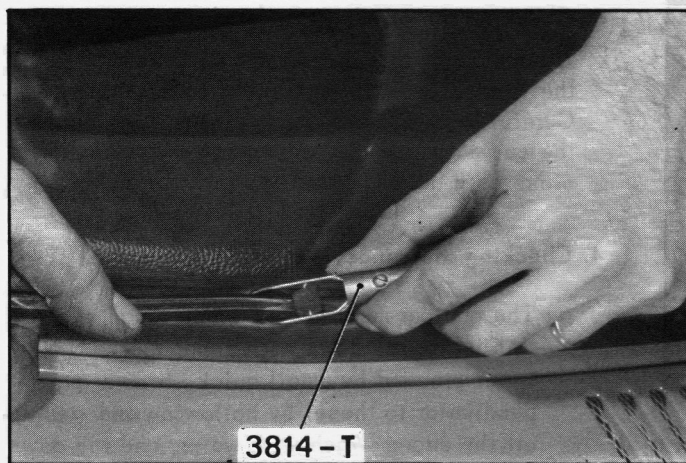

## FITTING

7. Offer up the windscreen to the frame, check from interior, its centre-line position.

## 8. Fitting the windscreen :

While an assistant exerts slight pressure from the exterior towards the interior, disengage the cord.

a) Pull on the cord, parallel to the glass in the following manner :

- 1) on the loop (1) up to « a »
- 2) on the end (2) up to « b »
- 3) on the loop (3) up to « c »
- 4) on the loop (4) up to « d »

b) Finish each side from « a » to « b » and « c » to « d ».

c) Exert slight pressure at the centre of the windscreen, to allow it to fit properly in the side pillars.

d) Pull on the cord ( the interior part having already been disengaged ) go round the windscreen, checking the positioning of the rubber sealing strip on the frame at the lower area « e ».

e) Finish fitting by tapping on the sealing with the palm of the hand, to ensure its final fitting position.

f) Check the positioning of the rubber sealing around the contour of the frame interior and exterior.

g) Check the positioning of the setting strip, and fit it, using tool 3814-T, if necessary.



## REPLACING A SIDE WINDOW

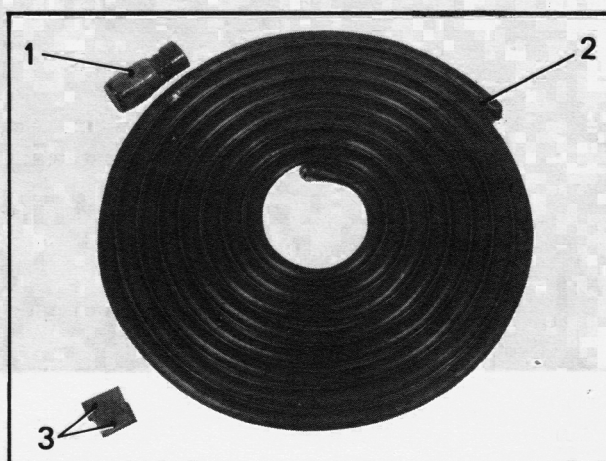
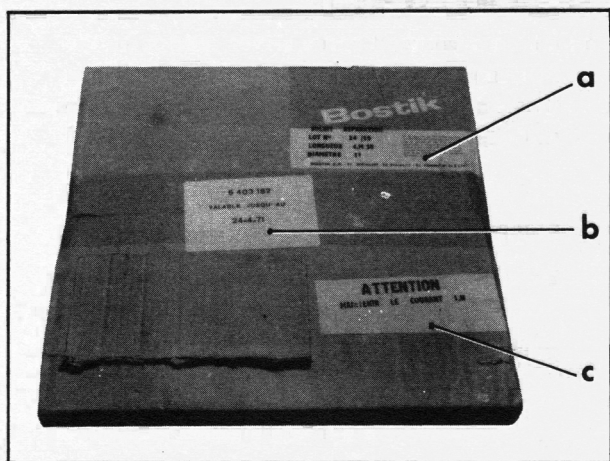

## PRODUCT USED

The product used for bonding a side window is an extruded neoprene strip containing a vulcanizing agent and built-in electrical resistor.

Vulcanization is achieved by passing an electrical current (see chapter MATERIAL USED paragraph b).

This product, manufactured by BOSTIK Company, is called SOLBIT.

It is available in two grades :

- a) One, for manufacturing purposes, has a shelf life of only five weeks at ambient temperature, or for an unlimited period below 0°C.
- b) The other, for repair purposes, has a shelf life of six months at ambient temperature.  
The repair strip is sold by the Replacement Parts Department in cardboard cartons.  
The three labels on the boxes indicate respectively :  
Label « a » : the physical properties of the product (length, diameter, production date, etc.. ).  
Label « b » : the Replacement Parts number and the date after which it must not be used.  
Label « c » : vulcanizing time to be observed during fitting (one hour).

Inside the box there is :

- A SOLBIT strip (2) - A bottle (1) of primary liquid - 2 rubber blocks (3) - A strand of piano wire about 0.60 meter long - An instruction sheet.

## EQUIPMENT USED.

## a) Standard tools :

- Philips screwdriver
- A hammer
- A dolly
- A roll of adhesive paper
- Three lengths of piano wire (diameter 0.6 mm-length = 500 mm).

## b) Special tools :

- A set of three straps 3822-T
- Two handles 3905-T
- A transformer delivering 27 V ± 1.5 V from voltages of 220 or 380 V ± 20 V.
- Two electric leads (cross-section = 4 mm<sup>2</sup> length = 2.5 mm) (connection between transformer output and the SOLBIT strip).

## REMOVAL

1. Clean the outside face of the glass with alcohol and position the handling suction cups.

## 2. Remove the side window :

- a) Using a cranked screwdriver, perforate the SOLBIT strip to allow insertion of a piano wire (dia. = 6 mm, length = 500 mm) between the window glass and the rabbet.

Fit the handles 3905-T on each end of this piano wire.

By alternately pulling and pushing, split the SOLBIT strip right round the periphery of the window.

11 461



## NOTE :

The side window having been removed with its trim, use a spatula to raise the trim at each corner so that its base, embedded in the SOLBIT, will in no way interfere with the piano wire.

Carefully cut out the SOLBIT strip at the bottom of the glass to avoid damage to the side trim that covers the rabbet.

- b) Remove the side glass with its trim.

## PREPARATION

3. Remove the side window trimmings.

4. With a blade, remove the traces of SOLBIT adhering to :

- the glass,
- the rabbet,
- the trim.

11 465

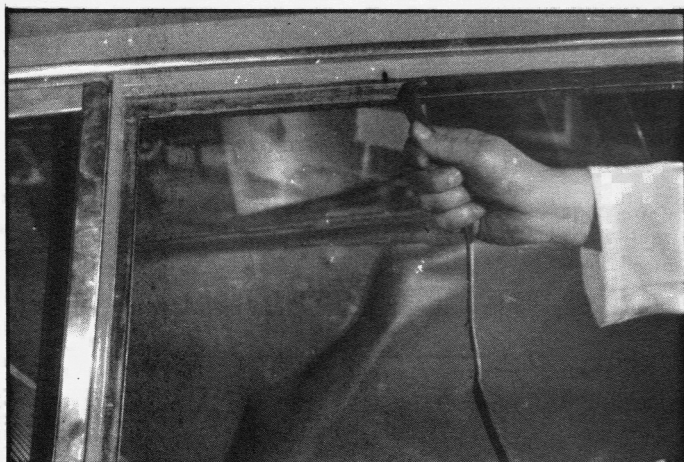

NOTE : It is not necessary to completely strip the glass and the bottom of the rabbet, since the new SOLBIT adheres perfectly to the old. However, it is best to avoid too much excess thickness (rub them down if necessary).

## FITTING

5. Place the glass in its rabbet.

The clearance between the rabbet and the glass should not exceed 4 mm.

If necessary, once more drive out the bottom of the rabbet to obtain this condition.

Place the two rubber blocks at the bottom of the glass (stick them if necessary).

6. Carefully clean with alcohol :

- the rabbet,
- the periphery of the glass ( inside face ),
- the trim surround.

9510

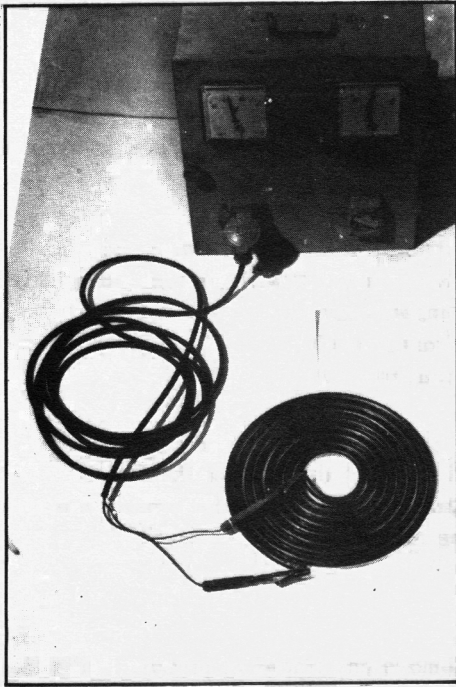

11 467

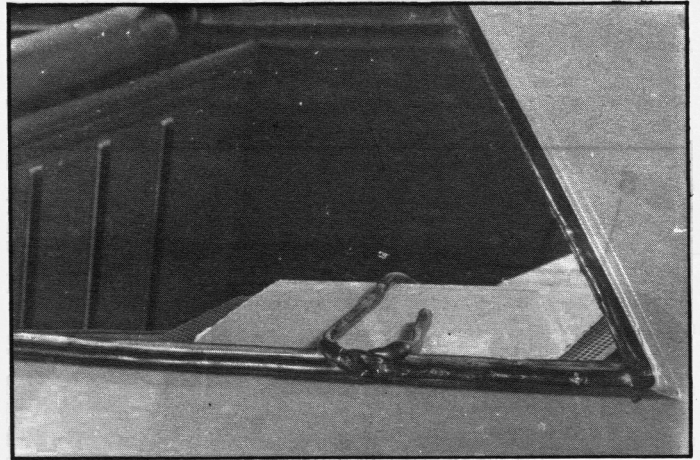

7. Using a thin paint brush, smear primary liquid on :
- the rabbet,
  - the inner face of the glass along its entire periphery for a width of about 20 mm.

11 468



8. **Preheat the SOLBIT strip :**

Connect up the ends of the resistor to the current source.

*Disconnect the resistor when the SOLBIT is soft and slightly sticky.*

(Continue surveillance - maximum time : three minutes ).

9. **Fit the SOLBIT strip :**

Fit the SOLBIT strip in the rabbet ( Protect the inner boot trim from contact with the SOLBIT )  
Cross the ends of the SOLBIT strip at the rear bottom corner of the window opening.  
Hang the ends inside.

*Crush the joint, so as to avoid extra thickness at the SOLBIT strip.*

10. **Fit the glass :**

Position the glass in its rabbet.

It should rest on the two rubber blocks at the bottom.

11. **Heat the SOLBIT strip :**

Connect the end of the SOLBIT strip to the current source.

12. **Press all around the glass so that it takes up its final position and to allow the SOLBIT strip to flow in between the glass and the rabbet.**

Remove the rubber blocks fitted in paragraph 5.

11 469



**IMPORTANT :** Let the SOLBIT strip heat for an hour. This time is essential for perfect vulcanization of the strip.

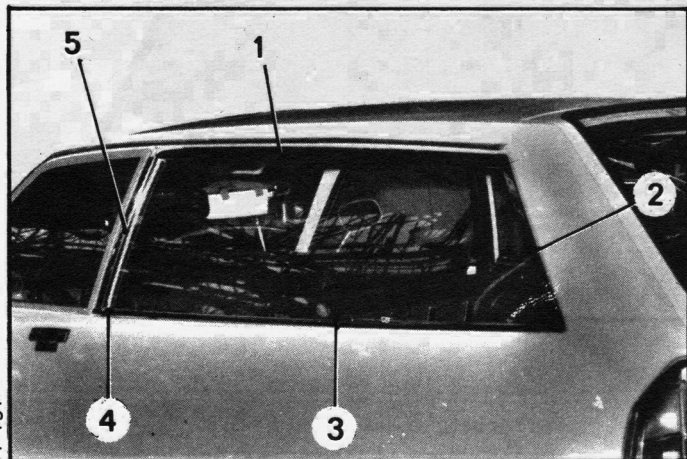

### 13. Fit the trim :

*Proceed with the fitting while the SOLBIT strip is vulcanizing.*

Fit the trim in the following order :

- lower trim (3) with its end-piece (4),
- upper trim (1),
- front trim (5),
- rear trim (2).

### 14. Disconnect the ends of the strip.

After cooling, press the ends of the strip against the rabbet.

### 15. Remove any traces of primary liquid from the glass using alcohol.

If the bodywork has been marked by the SOLBIT strip dab at the spots using the free ends of the strip.

Wipe afterwards with a soft petrol-impregnated cloth.

## REPLACING A REAR WINDOW

9316



## REMOVAL

1. *Case of an electrically-heated window* : disconnect the supply leads.
2. Lie on the rear seat with feet flat against a corner of the glass near the rubber sealing.  
Push on the glass until it is completely free.
3. Remove the sealing compound and carefully clean the rabbet of the opening.
4. Remove the glass sealing rubber.
5. Remove the seal trim (*on certain CLUB vehicles*).



## FITTING

## 6. Prepare the opening :

Carefully clean the rabbet.

Spread the sealing compound over a length of about 5 cm at the bottom two corners of the opening.

*In the case of an electrically-heated window :*

spread the compound in the same way at the height of the supply leads.

## 7. Fit the rubber sealing on the rear window glass.

8. Fitting the seal trim *on certain CLUB vehicles* :

Fit a small cord into the relevant groove of the rubber seal.

Fit the two parts of the trim while pulling on the cord.

Fit the seal cover.

## 9. Fit a small cord ( dia. = 4 mm ) smeared with soapy water, in the groove of the rubber. The ends of the cord must cross themselves in the middle of the lower portion of the glass.

## 10. Fit the glass in the opening with the ends of the cord towards the inside of the vehicle.

## 11. Press hard on the outside of the glass as close as possible to the rubber seal while an assistant inside the car draws on one of the cord ends ( this serves to raise the inner lip of the rubber seal and allows the latter to be fitted on the rabbet ). Continue to press all around the glass while removing the cord.

## 12. Complete fitting by tapping with a rubber mallet on the outside of the glass, all around it and as close as possible to the rubber seal.

## I. REPLACING A « BONDED » TAILGATE WINDOW

## PRODUCT USED

9417

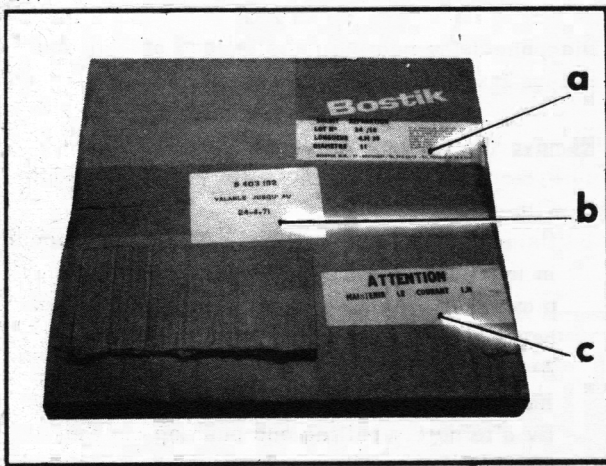

9283

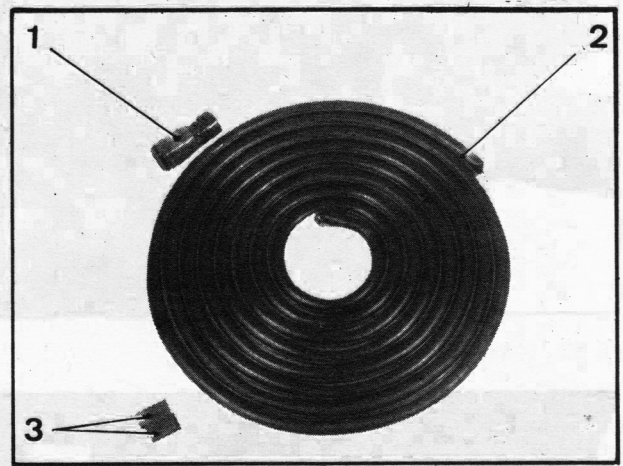

The product used for bonding tailgate windows is an extruded neoprene strip containing a vulcanizing agent and a built-in electrical resistor.

The **vulcanization** is achieved by passing an electrical current (see chapter MATERIAL USED paragraph b). This product, made by the BOSTIK Company, is called SOLBIT.

The product comes in two grades :

- a) The first, for manufacturing purposes, has a shelf life of five weeks at ambient temperature or an unlimited life below 0° C.
- b) The second, used for repair purposes, has a shelf life of six months at ambient temperature.

The repair strip is sold by the Replacement Parts Department in cardboard cartons.

The three labels on the carton indicate respectively :

Label « a » : the physical properties of the product (length, diameter, production date, etc..).

Label « b » : the Replacement Parts number and the final date of **use which must never be exceeded**.

Label « c » : the vulcanizing time to be observed when fitting (one hour)

Inside the carton there is :

- A strip of SOLBIT (2) - A bottle (flask) of primary liquid - Two rubber blocks (3) - A length of piano wire about 0.60 meter in length - An instruction notice

## EQUIPMENT USED

## a) Standard tools

- Philips screwdriver
- A hammer.
- A dolly
- A roll of adhesive paper
- Three lengths of piano wire (dia. = 0.6 mm - length = 500 mm).

## b) Special tools

- A set of three straps 3822-T
- Two handles 3905-T
- A transformer giving 27 V ± 1.5 V from voltages of 220 V or 380 V ± 20 V.
- Two electrical leads (cross-section = 4 mm<sup>2</sup> length = 2.5 m) (connection between the transformer output and the SOLBIT strip).

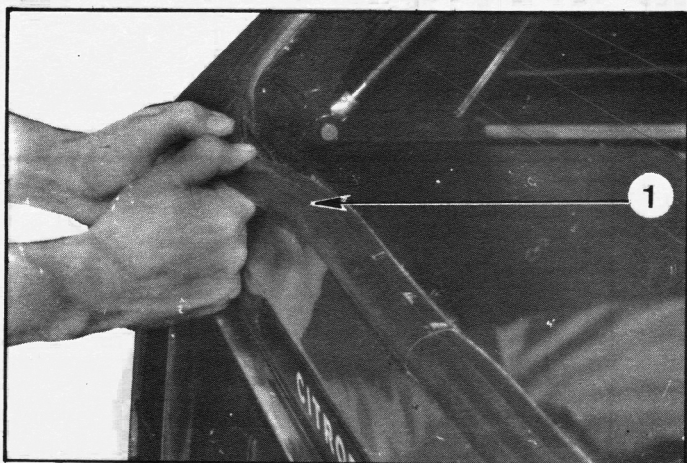

## REMOVAL

1. Remove the finish rubber.  
*Pull hard to free it from the glass.  
Do not re-use this rubber.*
2. Disconnect the heating resistor lead at "a" and remove the bolt (2) holding the earth wire.
3. **Remove the tailgate window :**
  - a) Protect the paint on the outside of the tailgate with adhesive paper.
  - b) Using cranked screwdriver, make a small opening in the SOLBIT strip to allow insertion of a piano wire (dia. = 0.6 mm - length = 500 mm) between the glass and the rabbet.  
At each end of this piano wire fit the 3905-T handles.  
By alternately pulling and pushing cut the SOLBIT strip right round the glass.
  - c) Remove the tailgate window glass.  
*The use of suction cups will facilitate this operation.*

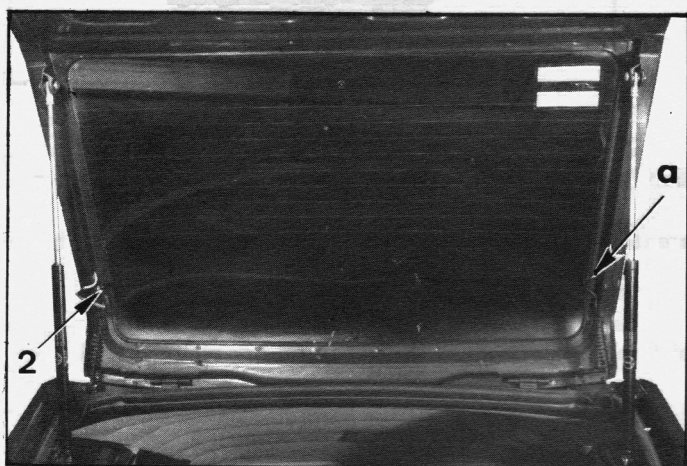

## PREPARATION



4. Using a knife, remove any traces of the SOLBIT strip adhering to the glass and rabbet.

If necessary, rub down the window rabbet.

NOTE : It is necessary to strip the glass and the steel completely since the new SOLBIT adheres perfectly to the old. However, it is wise to avoid too much extra thickness (rub them down if necessary).

5. Fit the new finish rubber on the tailgate glass, stick it if need be.

6. Carefully clean with alcohol :
  - the rabbet,
  - the periphery of the glass and the rubber ( bonding area ).



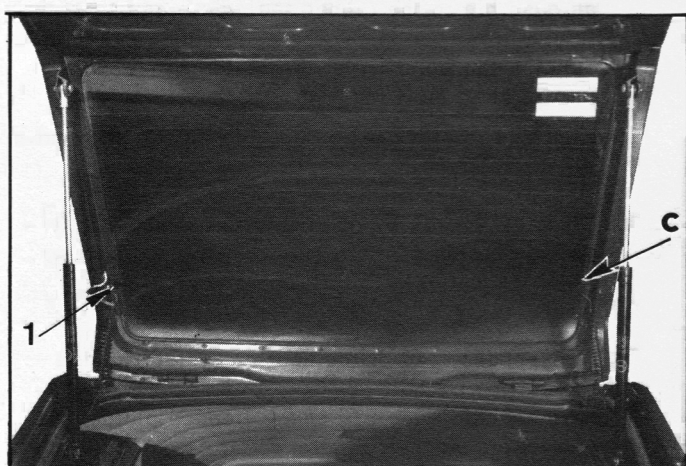
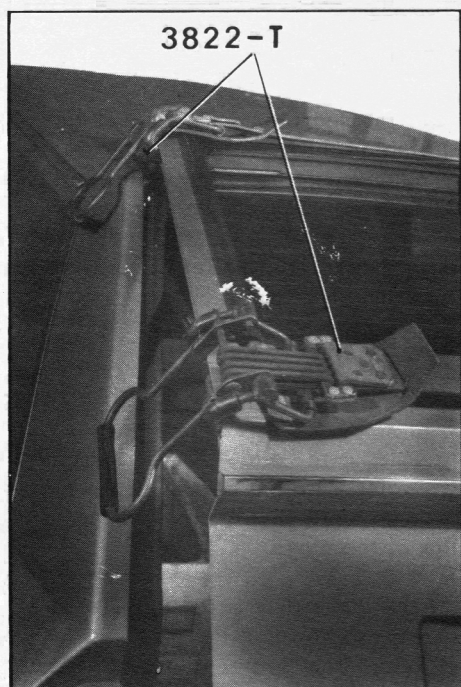
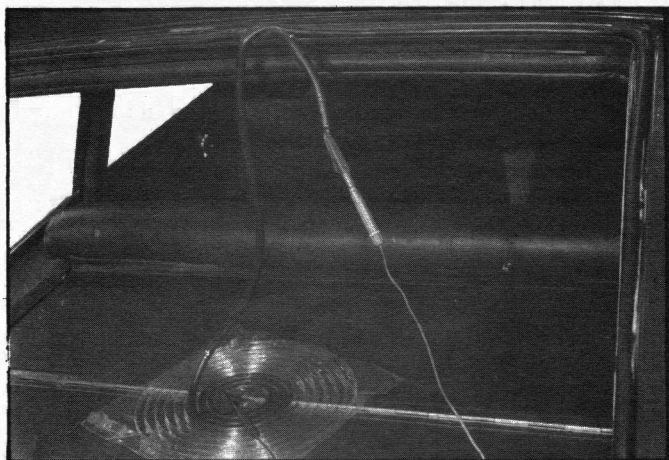

## FITTING

7. Using a thin paint brush, apply primary liquid to :
  - the rabbet,
  - the inner face of the glass along its entire periphery over a width of about 20 mm.
  - the finish rubber.

## 8. Preheat the SOLBIT strip :

Connect the ends of the resistor to a 24 volt current source.

*Disconnect the resistor when the SOLBIT is soft and slightly sticky.*

*( continue surveillance, maximum time = three minutes ).*

9. Fit the SOLBIT strip in the rabbet, crossing its ends at the top at the centreline of the body. Hang the ends inside.

*Press down the junction to avoid too great a thickness of SOLBIT.*

*Do not cut the SOLBIT strip to length.*

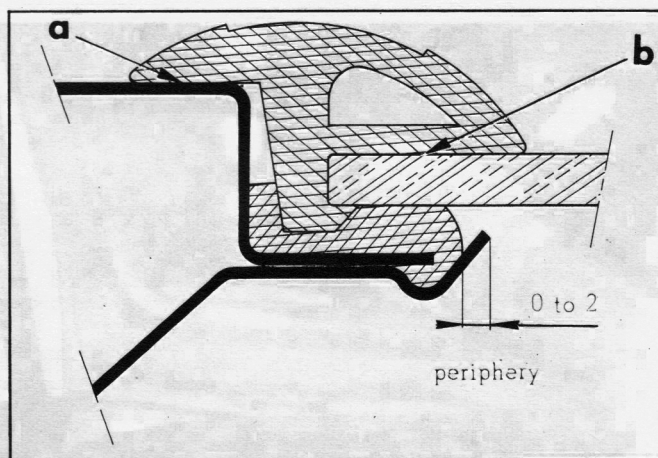

## 10. Fit the glass :

Fit the glass with its finish rubber on the SOLBIT strip.

## 11. Heat the SOLBIT :

Connect the ends of the SOLBIT strip to a 24 volt current source.

12. Press around the glass so that the glass assumes its definitive position and allow the strip to flow between the glass and the rabbet.

Check that the finish rubber lies flat along the centre periphery at « a » on the rabbet and « b » on the glass.

**IMPORTANT :** Let the strip heat for an hour. This time is essential to obtain perfect vulcanization of the strip.

13. Disconnect the ends of the strip.

Remove the two 3822-T straps.

*After cooling, the ends of the strip against the rabbet.*

14. Use alcohol to remove all traces of primary liquid from the glass.

If the bodywork has been marked by the SOLBIT strip, dab the spots with the free ends of the strip.

Then, wipe with a soft petrol-impregnated cloth.

15. Connect the lead to the heating resistor at « c » and fit the bolt ( 1 ) holding the earth wire.

## II. REPLACING A « SET-IN » TAILGATE WINDOW

### REMOVAL.

1. Disconnect the heating resistor lead and remove the earth wire bolt ( 2 ).  
Disconnect the lead ( 1 ) from the licence plate light and unfasten the conductors at « a » on each side of the tailgate window.
2. Using a spreader release the upper corners of the sealing rubber.  
Press on the glass to facilitate the passage of the rubber seal lip.  
End the removal while releasing completely the glass from the tailgate.
3. Remove the rubber sealing strip.

### PREPARATION.

4. Remove the sealing compound and carefully clean the tailgate rabbet.  
If necessary, file down any welding ridges.  
If necessary, rub down the rabbet.
5. At each corner, fit a pellet of new compound drawn out to a length of about 50 mm.

### FITTING.

6. Fit the tailgate window glass into its rubber seal.
7. Fit a small cord ( dia. = 4 mm ), smeared with soapy water, into the groove of the rubber seal. The ends of the cord should cross at the centre of the bottom of the glass.
8. Place the glass thus fitted into its opening, with the cord ends towards the inside of the vehicle.
9. Press hard on the outside of the glass as close as possible to the rubber seal while an assistant inside draws on one of the cord ends ( this serves to raise the inner lip of the rubber and allows the latter to be fitted on the rabbet ).  
Continue to press all around the glass and remove the cord.
10. Complete fitting by tapping with a rubber mallet on the outside of the glass, all around it and as close as possible to the rubber seal.
11. Connect the lead of the heating resistor and fit the earth wire bolt ( 2 ).  
Connect the leads ( 1 ) of the licence plate light and fasten on the tailgate at « a » ( on each side ).

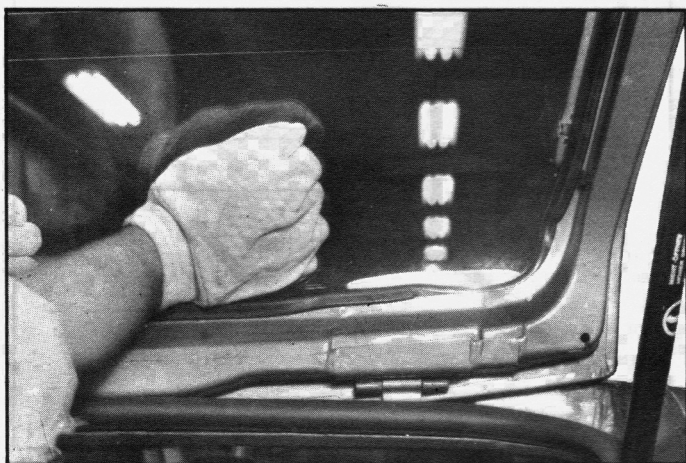
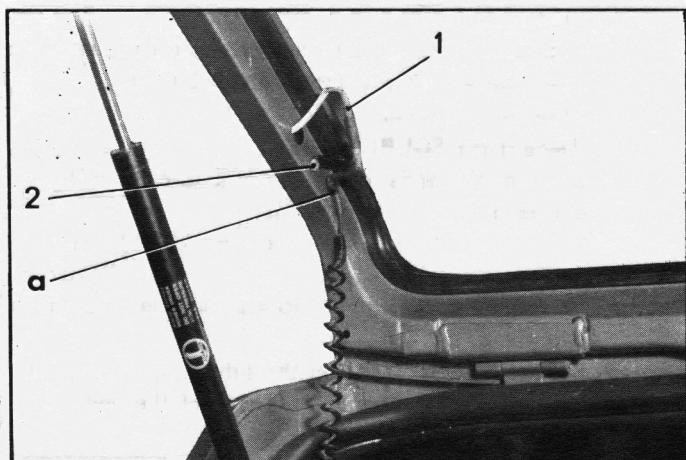

# MR. 630\_84/14

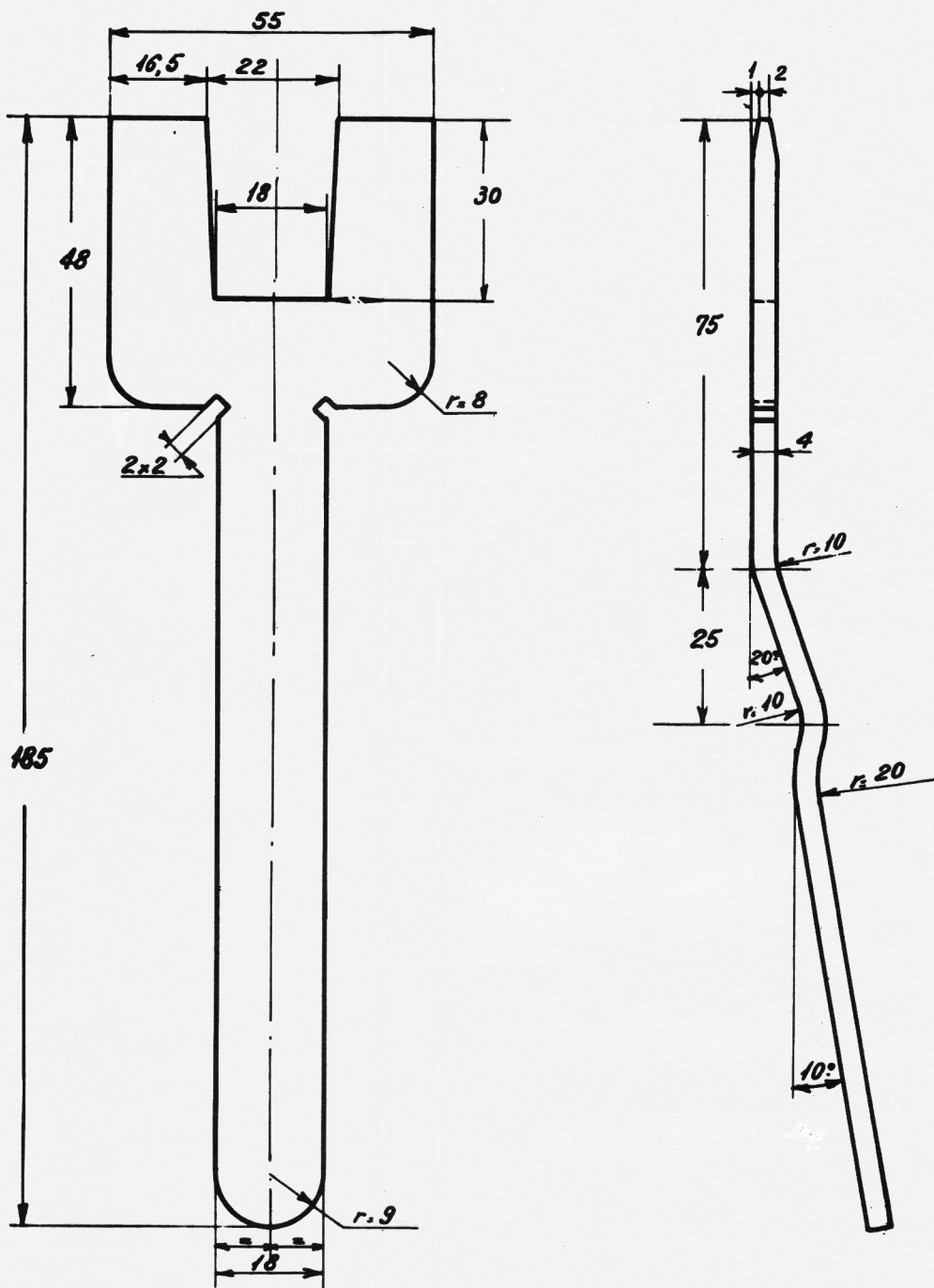

Manual 810-2

# MR.630\_84/21

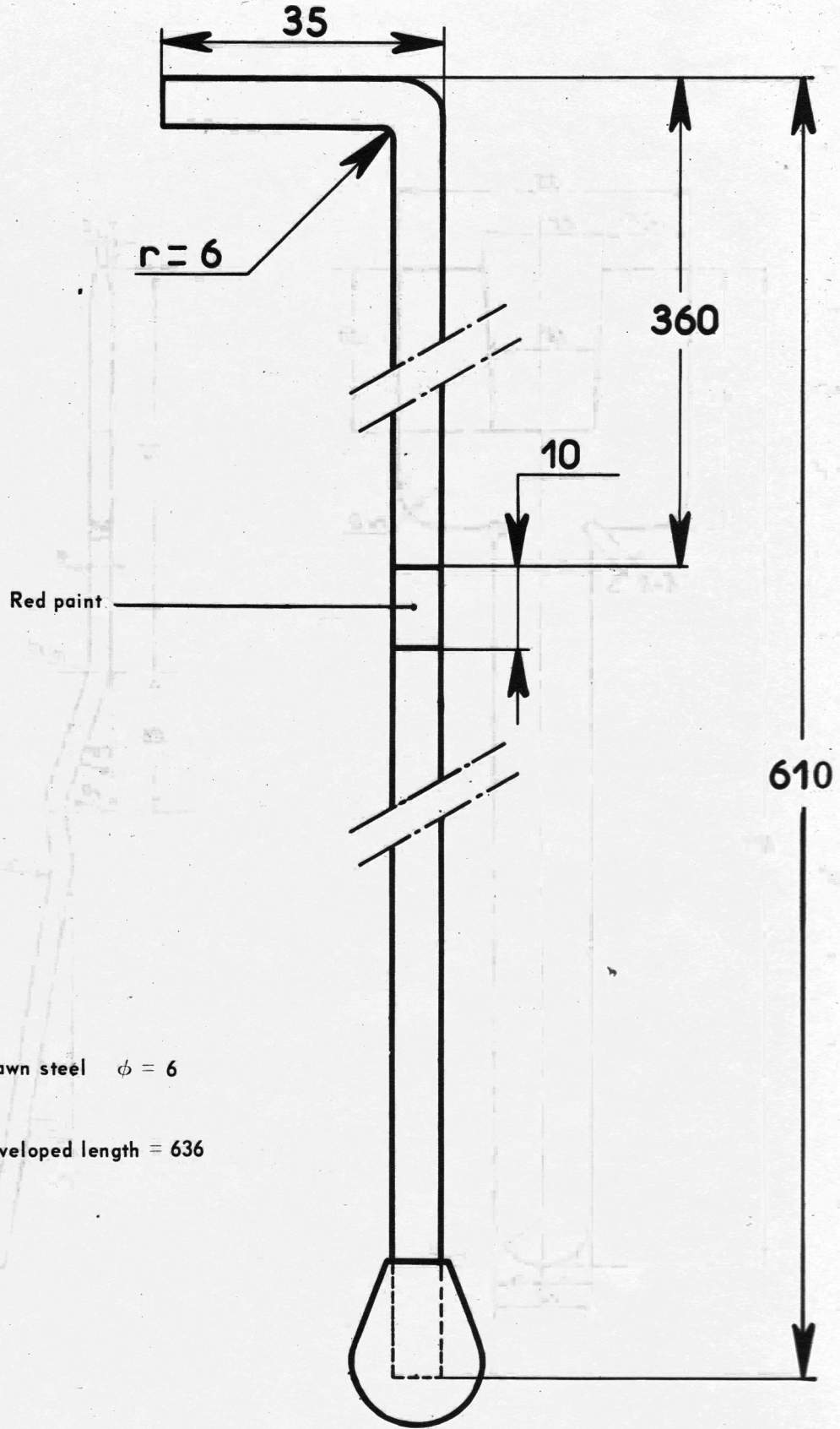

Drawn steel  $\phi = 6$

Developed length = 636